



PROVEN & TRUSTED SINCE 1952

Electric Fryer GBF-70

Operation & Service Manual



MODELS:

Single: GBF-70

2-Bank: GBF-70/70

3-Bank: GBF-70/70/70



CAUTION: Read instructions before using this appliance.

GILES Food Service Equipment

ISO 9001-2015 Certified

2750 Gunter Park Drive West • Montgomery, AL 36109 USA

Phone 334.272.1457 • Fax 334.239.4117 • Phone Toll Free 800.554.4537

Website: www.gfse.com • Email: services@gfse.com

66320
REV-C
ECO3395
02/14/2025
PRINTED IN USA

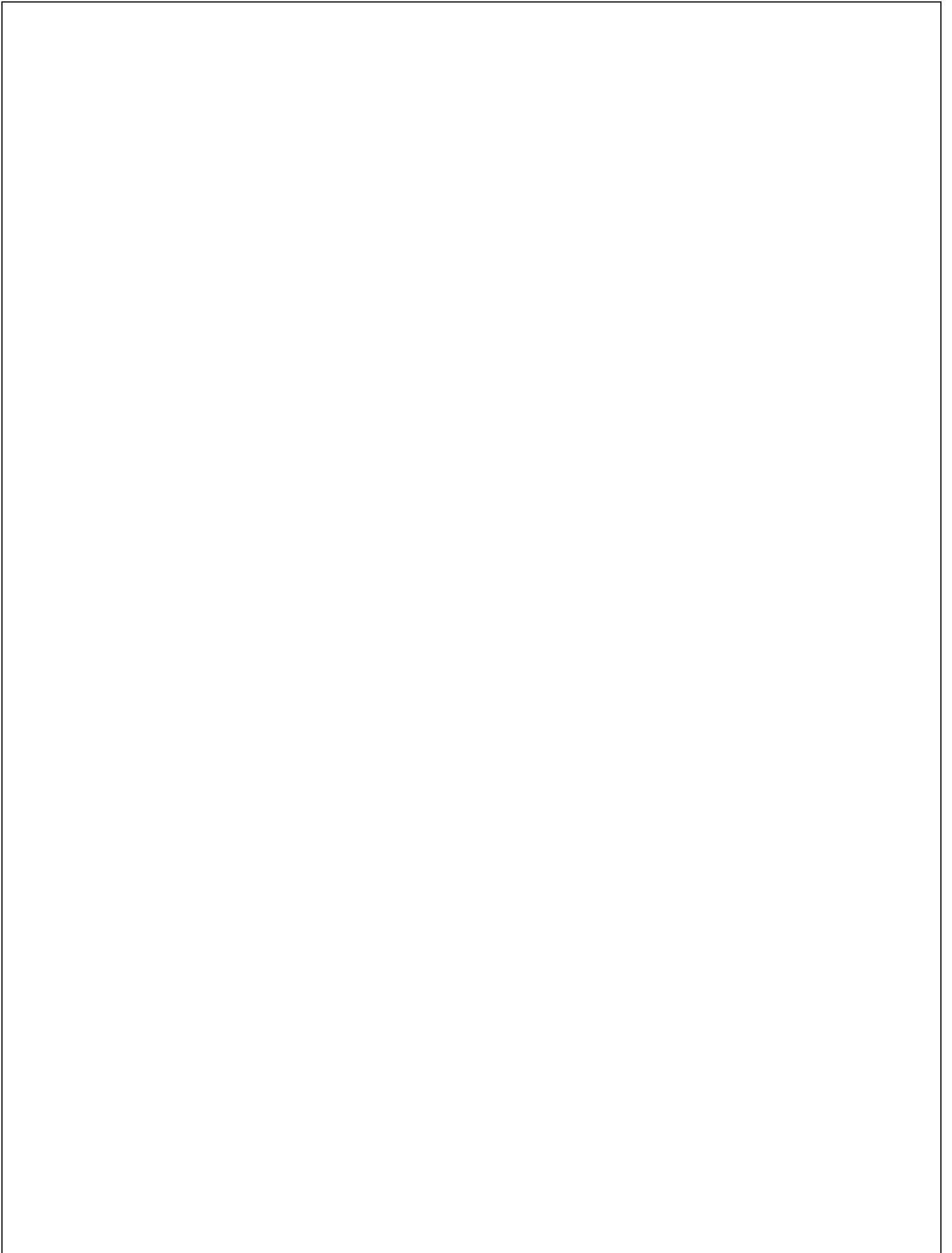



LIMITED WARRANTY

- Subject to the terms and conditions of this Limited Warranty as herein stated, all Giles Enterprises Inc. (hereafter referred to as "Giles") food service equipment and parts purchased new from an authorized Giles representative are warranted as to defects in material or workmanship for a period of twenty-four (24) months from the date of installation, provided, however, that with regard to labor costs in connection with this warranty, see below. All installations must be made by a qualified installing agency in accordance with all applicable codes and/or regulations in the jurisdiction in which installed. Limited warranty coverage is extended only to the original owner and is void if the unit is resold.
- During the Limited Warranty period, Giles will replace or recondition, at its factory, any part or parts of this unit which Giles inspectors judge defective, provided the unit has been properly installed, subjected to normal usage, and operated and maintained in accordance with specified procedures. This Limited Warranty does not cover cosmetic damage, and damage due to acts of God, accident, misuse, alteration, negligence, abuse, or use of unorthodox repair methods. All parts replaced under this Limited Warranty carry only the unexpired term of this Limited Warranty. Limited Warranty service may be furnished only by an authorized Giles service representative.
- If Limited Warranty service is requested, Giles will dispatch factory-authorized service representatives to inspect, repair, recondition, or replace units of its manufacture with such labor being rendered without cost to owner for twenty-four (24) months from the date of installation. Otherwise, service, including labor and transportation charges or other expenses, in connection with the removal or installation of any part or parts supplied under this Limited Warranty, are specified on the original sales contract between the purchaser and the authorized Giles representative.
- **Failure to use Giles OEM replacement parts and Giles OEM filters may void this Warranty.**
- Giles reserves the right to change or improve its equipment and/or parts in any way without obligation to alter such equipment or parts previously manufactured.
- Giles makes no further warranties, express or implied, including implied warranties of merchantability or fitness for a particular purpose, and has no other obligation or liability not specifically stated herein.
- Repair or replacement as provided under this limited warranty is the exclusive remedy. Giles shall not be liable for any incidental or consequential damages for breach of any express or implied warranty on this product, except to the extent prohibited by applicable law. Any implied warranty of merchantability or fitness for a particular purpose on this product is limited in duration to the duration of this limited warranty.
- Used Giles food service equipment or parts, or Giles food service equipment or parts not purchased from an authorized Giles representative, carry no warranties, express or implied.

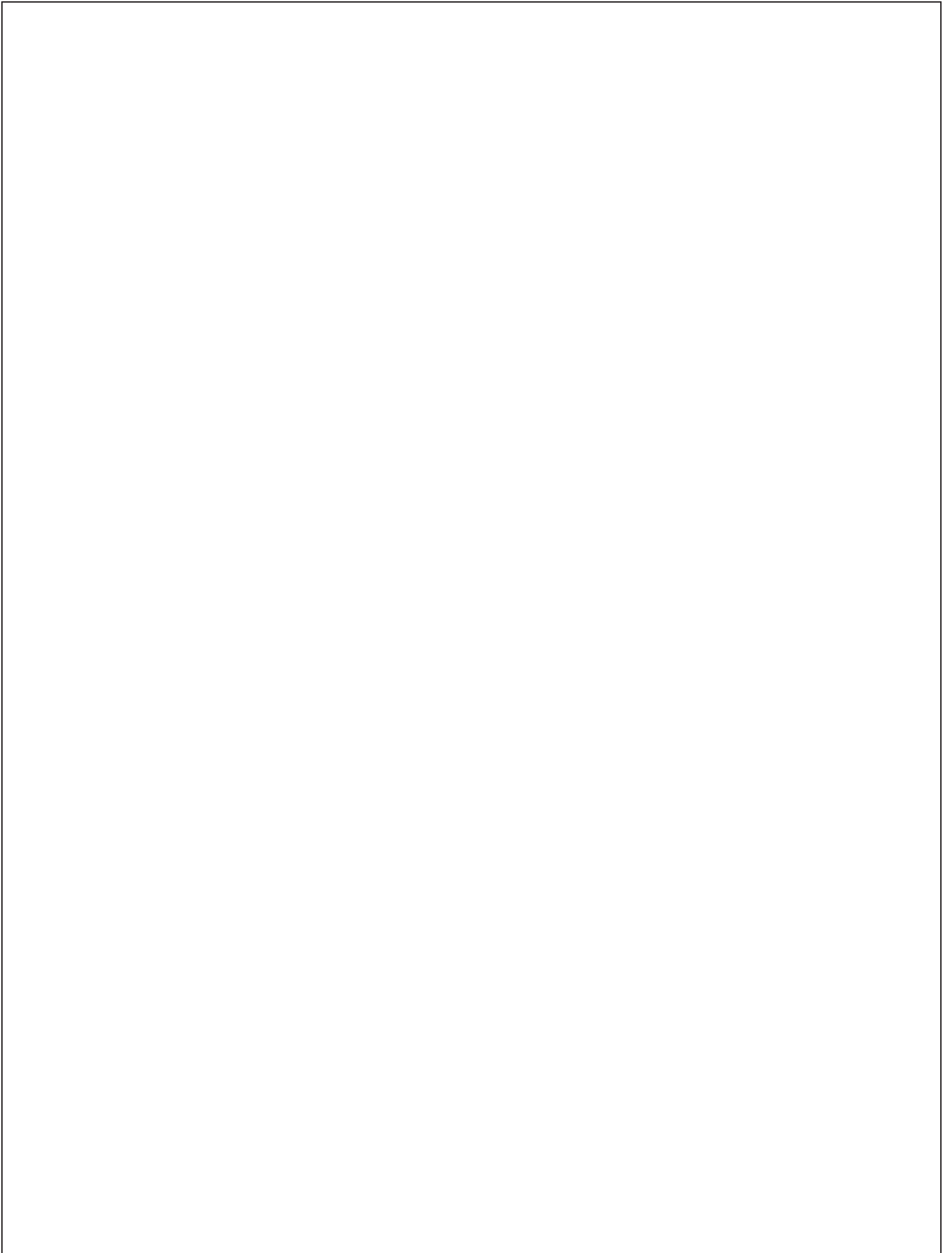

Safety	iv
Safety Overview	iv
Specific Safety Precautions	v
1. Introduction	1
1.1 Construction	1
1.2 Standard Features	1
1.3 Optional Features	1
1.4 Specifications	2
1.4.1 Overall Dimensions	2
1.4.2 Agency Certifications	3
1.4.3 Basket Size	3
1.4.4 Vat Size & Capacity	3
2. Installation	5
2.1 Appliance Location	5
2.2 Unpacking	6
2.3 Electrical Requirements	7
2.4 Electrical Specifications: Single & Banked (per Fryer Unit)	7
2.5 Electrical Connection	7
2.5.1 Electrical Connection Diagram	8
2.6 Ventilation	8
2.7 Fryer Options - Added to Purchase	9
2.7.1 Bulk Oil Management System Connections	9
2.7.2 On-Board Oil Top-Off System	9
2.8 Restraint Device (Not Included)	10
2.9 Finalizing Installation	10
2.9.1 Power Test	11
2.9.2 Heat Test	12
2.9.3 Filter Pump Test	13
2.9.4 Initial Fryer Cleaning (Boil-Out Procedure)	13
2.9.5 Clean Filter Pan, Accessories & Appliance	14
2.9.6 Optional KITCHENTRAC™ Remote Monitoring Option	14
3. Overview	15
3.1 Control Panel	16
3.2 Lower Cabinet	18
3.3 Filter Pan Assembly	20
3.4 Basket, Elevator Assembly & Oil Saddle Tank	22
3.5 Accessories (Provided)	24
3.6 Accessories (Not Included)	26
4. Fryer Operation	29
4.1 Computer Controller	30

4.1.1	Keys & Functions	30
4.1.2	Controller - General Overview	32
4.1.3	Setting the Cooking Temperature	33
4.1.4	Manually Setting the Cooking Time	34
4.1.5	Working with Item Menu Presets	35
4.1.5.1	Editing a Menu Item Preset	36
4.1.5.2	Selecting a Menu Item Preset for Cooking	39
4.1.6	Cooking Cycle General Overview	41
4.1.7	Manually Operating the Basket Lifts (<i>If Equipped</i>)	42
4.1.8	COOL Mode	43
4.1.8.1	AUTO-COOL Feature	43
4.1.9	BOIL-OUT Program	43
4.1.10	User Settings	44
4.1.11	PASSWORD Protection	45
4.1.12	Power-Up Procedure	45
4.1.13	Controller Errors/Alarms	46
4.1.13.1	Clearing Controller Errors & Alarms	47
4.2	Cooking Procedures	48
4.3	Optional Oil Level Top-Off Function	53
4.4	Filtering Used Cooking Oil Using On-Board System	54
4.5	Normal Shut-Down	57
4.6	Emergency Shut-Down	57
5.	Cleaning & Maintenance	59
5.1	Removing & Disposing of Waste Cooking Oil	59
5.2	Boil-Out Procedure - Cleaning the Fry Vat	61
5.3	Cleaning the Filter Pan & Refreshing Filter Media	63
6.	Troubleshooting	65
6.1	Temperature Control System	65
6.2	On-Board Oil Filtration Problems	67
6.3	Oil Top-Off System Problems	68
6.4	Filter Pump Problems	68
6.5	Basket Lift System (<i>If Equipped</i>)	69
7.	Parts Lists	71
7.1	Parts Ordering & Service Information	71
7.2	Control Panel - Single Unit & Banked System Main Unit	72
7.3	Front Header Component Box (behind Control Panel of Each Unit)	74
7.4	Lower Cabinet - Single or Banked Main Unit	76
7.5	Lower Cabinet - Banked Add-on Unit with J.I.B. Option	78
7.6	Plumbing Components - Single Fryer	80
7.6.1	Plumbing Components - Double Bank Fryer	82
7.7	Rear Cabinet - Single Unit	84

7.8	Rear Cabinet - Double Bank Unit (with J.I.B. Option)	86
7.9	Fry Vat Assembly (per Vat)	88
7.10	Filter Pan Assembly	90
7.11	Baskets, Panels, & Covers	92
APPENDIX [A] - Connecting Optional <i>KITCHENTRAC™</i>		95
A.1	Connecting WIFI Board to Wireless Router	95
A.2	Establishing Communication with <i>KITCHENTRAC™</i> Server	96
A.3	WIFI Components	97

Safety Overview

The information contained in this manual has been prepared to explain proper procedures for safely installing, operating and maintaining *Giles Food Service* appliances and equipment.

 **Hazard Alert Symbols** are used throughout the manual, along with key words ***DANGER, WARNING, and CAUTION*** to alert users to potential personal injury hazards and/or poor operating practices. The alert will immediately precede precautionary information regarding avoidance of such hazards or practices. Adhere to all information presented to avoid possible injury, or even death. Failure to do so may also void the factory warranty.

Suggested, recommended, or other noteworthy information will be identified as ***NOTES***, or will be labeled as ***IMPORTANT!***. Additionally, certain words are used to indicate specific meaning, or to add emphasis as follows:

- Shall:** understood to be mandatory.
- Should:** understood to be advisory.
- May:** understood to be permissive.
- Will:** indicates a future event or condition to occur.

 *This product can expose users to chemicals including lead, nickel, aluminum, cadmium, brass, carbon, copper or BPA which are known in the state of California to cause cancer, birth defects and other reproductive harm. For more information go to: www.p65warnings.ca.gov.*

DANGER

Indicates an imminently hazardous situation which, if not avoided, will result in serious personal injury, even death.

WARNING

Indicates a potentially hazardous situation which, if not avoided, could result in serious injury, even death.

CAUTION

Indicates a potentially hazardous situation which, if not avoided, may result in minor to moderate injury. This notification is also used as an alert to unsafe practices.

CAUTION

If used without the hazard alert symbol, indicates a potential situation which, if not avoided, may result in equipment and/or property damage, and may void the factory warranty.

NOTE or IMPORTANT!

Identifies suggested, recommended, or other important information.

Specific Safety Precautions:

For your safety, please observe the following precautions when operating or servicing the **GBF Electric Fryer**. Adhering to the following important safety precautions will help users avoid personal injury and/or damage to the equipment.

DANGER

- Before cleaning or performing maintenance, place power switch in the [OFF] position. To remove all power from unit, either unplug power cord or turn OFF power at the electrical panel supplying power for the appliance.
- **DO NOT** wash down the fryer interior or exterior with water spray. Control panels are “*liquid resistant*”, but are not *washdown-safe*.
- Failure to comply with **DANGER** notices will result in serious injury, even death; or damage to equipment and/or property and may void the factory warranty.

WARNING

- Prior to installation, consult a professional electrician to ensure that installation will be compliant with all electrical requirements and local code, or in the absence of local code, in accordance with the **National Electrical Code, NFPA 70** and that electrical circuits (wiring, breakers, etc) supplying power for the appliance are of sufficient rating to safely power the appliance load. See rating label affixed to the unit and consult the provided wiring diagram.
- The unit must be adequately and properly grounded in accordance with the prevailing electrical codes. Improper grounding may result in electrical shock to user.
- Improper installation, adjustment, maintenance/service, or unauthorized modification can result in property/equipment damage, serious injury, or death, and will potentially void the factory warranty.
- **DO NOT** use or store flammable liquids, or materials that produce flammable vapors, in the vicinity of this or any other appliance!
- **DO NOT for any reason (or ALLOW OTHERS to) stand or step onto the top of the appliance.** Cooking oil in fryers is **EXTREMELY HOT, greater than 330°F [166°C]**. Bodily contact will cause extremely serious injury. **Lids used to sometimes cover cooking vats are not designed to, and WILL NOT, support the weight of a person.**
- Failure to comply with **WARNING** notices could result in serious injury, even death; damage to equipment and/or property; and will potentially void the factory warranty.



CAUTION

- The appliance must remain in an upright position.
- Exercise care when removing the unit from shipping pallet.
- **DO NOT** operate the appliance, unless the intended function of components & controls are fully understood (see **Section 3**). Closely follow the procedures and instructions in this manual to avoid equipment damage or malfunction.
- Exercise caution when operating and cleaning. **To avoid personal injury, wear thermal protective gear (gloves or mitts) while tending the appliance.** Certain parts of fryer will become very **HOT** during operation; temperatures inside the cabinet may exceed **150°F/65.5°C and cooking oil temperature is typically in excess of 330°F/166°C.**
- Placing foods containing excessive moisture into hot oil, or attempting to load a quantity of product that is larger than recommended batch sizes can cause a “surge boil” and cause an overflow of **HOT** cooking oil. Exercise due care when loading food, proceed slowly to observe how oil reacts before continuing.
- Be sure the appliance is positioned in a stable, safe location with the front caster wheel brakes locked. **DO NOT** operate appliance if not secured. Some jurisdictions may require special anchoring for this type of appliance ... check local code.
- Allow the appliance to cool for at least *15-20 minutes* before starting cleaning or service activities.
- This appliance is for professional use only and is to be operated by qualified personnel. It is not intended for use by persons (including children) with reduced physical, sensory, or mental capabilities, or those lacking experience and knowledge, unless they have been given adequate instruction and/or supervision concerning its operation by a person responsible for their safety. Restrict children from the vicinity of this appliance while in operation.
- Kitchen areas in which fryers are operated must be provided with adequate ventilation systems to remove grease-laden vapors and provide for fresh air return. Such systems must comply with local building, health and fire codes, and have approval of authorities having jurisdiction.
- Prior to sale for customer consumption, cooked food products must be maintained at a minimum holding temperature of **150°F/65.5°C**, or in accordance with governing health regulations.
- Failure to comply with **CAUTION** notices may result in minor to moderate personal injury, damage to equipment or property, and potentially void the warranty.

CAUTION

- Components exposed on control panel surface are impact-sensitive. To avoid damage and ensure proper operation, exercise care when working around or using carts & rolling tables near the appliance.
- **DO NOT** install the unit near combustible walls and materials. Failure to maintain safe distance may result in fire.
- When cleaning the appliance:
 - **DO NOT** steam clean.
 - **DO NOT** use products containing chlorine, or other corrosive chemicals.
 - **DO NOT** use abrasive products, steel wool or scouring pads.
 - **DO NOT** use oven cleaners.
- **DO NOT** alter, add attachments, or otherwise modify this equipment!
- Failure to comply with **CAUTION** notices may result in damage to equipment or property, and void the factory warranty.

NOTE:

- Installation, maintenance and repairs of this appliance should be performed only by qualified professional commercial kitchen equipment service technicians.
- Users must comply with all appropriate state and local health regulations regarding food service operations, and cleaning and sanitization of food service equipment.

1. Introduction

THANK YOU for purchasing the **Giles Model GBF-70 Electric Fryer**, manufactured by Giles Enterprises, Inc., Montgomery, Alabama (USA), hereafter referred to as "**GILES**". Every unit is thoroughly inspected and tested prior to shipment in an effort to ensure that it will operate flawlessly when received. With proper care and maintenance the appliance will provide years of trouble-free service.

To help protect your investment in this new equipment, we recommend that you take a few moments to become familiar with the procedures presented in this manual pertaining to installation, operation, cleaning, and maintenance. Adherence to these recommended procedures will minimize potential for costly downtime and future repair expense. **Please retain this Manual for future reference.**

NOTE: Due to continuing improvements and product enhancements, some illustrations shown in this Manual might not exactly depict your actual equipment.

1.1 Construction

Constructed of 18 & 20-ga, high-grade stainless steel sheet metal ... welded stainless steel tubular inner cabinet structure.

1.2 Standard Features

Computer Controller: Regulates cooking temperature and time. Dual cook timers, programmable menu item cooking presets for up to 50 products, continuous fryer monitoring, displays operational instructions and error/warnings ... **LOW OIL LEVEL, DRAIN OPEN, MAX. ELEMENT TEMP**, etc. Features **BOIL OUT** program, **COOL MODE** feature, **FORCE FILTER** function, multiple language selections, and password protection capability.

Built-in Oil Filtration System: Fully self-contained, proper use helps to extend the useful life of cooking oil. Has a robust 1/2 hp pump ... designed to perform the filtering cycle within approximately five (5) minutes. The centralized system serves all units of a multi-well configuration.

Multi-Well Frying: Expand capacity with a banked battery of 2 or 3 fryer wells.

1.3 Optional Features

Automatic Basket Lift: Two (2) basket lifts per unit. Automatically lowers and raises cook basket at start and end of a cooking cycle ... avoid over cooked product.

Bulk Oil Management System Connection: Connect to an existing bulk oil management system for delivering fresh cooking oil to fryers (*for vat filling & top-off*) and for disposal of waste oil.

Oil Top-off System: Maintain oil level in fryers with minimal effort. Avoid low oil conditions and provide for more consistent cooked food quality. On banked units, oil is pumped directly from a purchased jug of fresh oil. Single fryer unit utilizes a "*saddle-bag tank*" in which the fresh oil top-off supply is manually maintained by the user. *Top-off functioning is inclusive when fryer is connected to a bulk fresh oil system.*

WiFi Connectivity: The **KitchenTrac** app provides full-time monitoring of fryer activities and operations via your remote devices (laptop, tablet, smartphone). Keep track of loads cooked, idle-time, oil filtering, sales trends, and many other analytics associated with of cooking equipment utilization. *Small monthly server hosting fee is required.*

1.4 Specifications

1.4.1 Overall Dimensions

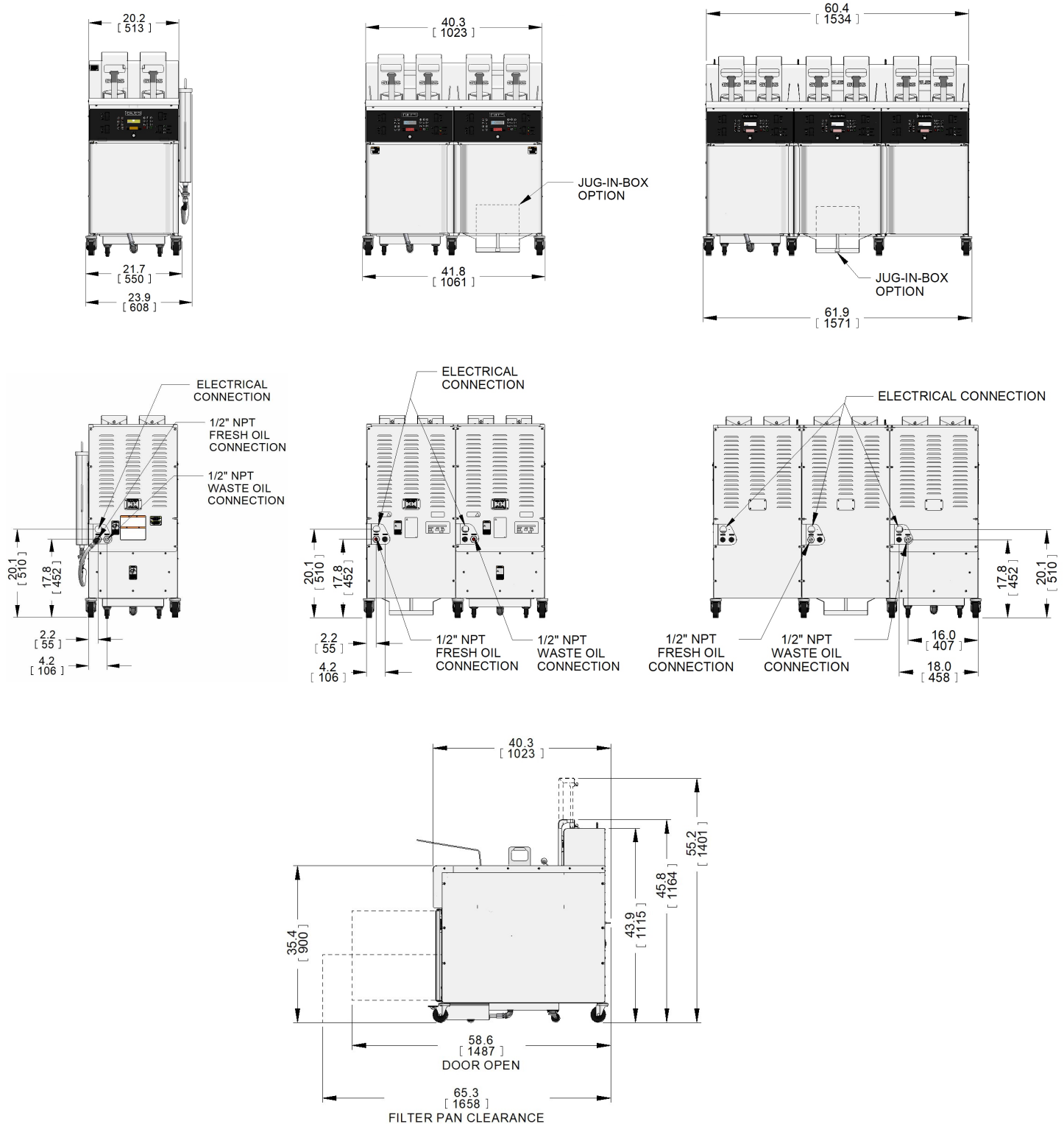

BANKED UNITS REQUIRE MINIMUM 44" [1100 mm] CLEARANCE (AISLE OR DOORWAY) FOR PASS-THROUGH

1.4.2 Agency Certifications



1.4.3 Basket Size

Description	Length	Width	Depth	Volume
Standard (2 per vat)	18-1/2 [470]	9 [229]	5-1/2 [140]	811 cu in [0.013 c m]

1.4.4 Vat Size & Capacity

Length (Inside)	Width (Inside)	Depth (Top of Element to "FULL" Level)	Cooking Oil Capacity (Bottom of vat to "FULL" Level)	
			Lbs [kg]	Gal [l]
19-19/32 [498]	18-1/8 [460]	5 [127]	70 [31.8]	9.9 [37.5]

INCHES [mm]

2. Installation

The following sections explain procedures necessary to properly install the appliance. To help avoid personal injury or equipment damage, please adhere to all recommended procedures.

Installation expenses (material & labor) are the sole responsibility of the customer. Generally, it is advisable to engage the services of professional commercial kitchen equipment specialists, a licensed electrician, and/or a qualified HVAC contractor to manage the specifics of an installation. You may call *Giles Technical Support* @ 800.554.4537, if assistance is required.

2.1 Appliance Location

CAUTION DO NOT MODIFY, ADD ATTACHMENTS OR OTHERWISE ALTER THIS EQUIPMENT

1. Appliance and the surrounding area must be free and clear of combustible materials. Maintain 3" [7.6 cm] clearance.
2. Provide adequate space to allow access for proper operation and future service activity.
3. Be sure that electrical service available in the intended location is of a voltage and amp rating adequate to power the appliance load. **NOTE:** *A banked system requires a separate electrical service for each fryer unit.*
4. Be sure the unit is installed in a stable position and will not unintentionally move. Front caster wheels have locking brakes ... be sure they are kept locked when operating. Some code authorities may require that special anchoring be utilized for this type of appliance ... check local code.
5. The appliance must be installed, operated, and maintained in accordance with the **Standard for Ventilation Control, and Fire Protection of Commercial Cooking Operations, NFPA 96**. Proper ventilation must be provided for the operating area as required by local code requirements.

These steps will help to ensure proper installation. If there are questions concerning these procedures, contact ***Giles Technical Support*** at 800.554.4537 or email ***services@gfse.com***.

2.2 Unpacking

The fryer and associated accessories are shipped on a wooden pallet, secured with high-tensile plastic strapping and enclosed by a protective wooden framework. The entire unit is wrapped in plastic stretch-film for protection.

IMPORTANT!

If crate showed evidence of damage or mishandling, the unit and all accessory items should have been thoroughly inspected. The freight carrier should be notified immediately about all suspected shipping damage. *Typically, it will be the responsibility of the purchaser to file and negotiate freight damage claims.*

CAUTION

- Keep the appliance upright while uncrating.
- Exercise care when removing any wooden framework from shipping pallet.
- Unit is **very heavy**, particularly banked systems. Exercise extreme care and use appropriate handling equipment and/or sufficient manpower when lifting and moving appliance from pallet.
- Failure to comply with **CAUTION** alerts may result in minor or moderate injury, equipment or property damage, and void the factory warranty.

1. Place the pallet in an area that provides adequate space for unpacking & uncrating.
2. Using appropriate tools, carefully cut and remove the plastic wrap, strapping and any other bracing and/or packing materials.
3. Accessory items such as cooking baskets, screens, filter pan, oil discharge hose, fryer tools, etc. are generally packed inside fryer cabinets or in the cook vats. Some items may also be stowed inside the filter pan. Secure all of these items and set aside in a safe place for future use.
4. Carefully remove appliance from shipping pallet. Fryers are very heavy, especially banked systems. Great care should be taken when lifting and moving the unit to avoid damage and/or personal injury. Use appropriate material handling equipment, or sufficient manpower. Once on the floor, unit should roll easily on the casters.

NOTE for BANKED UNITS: A minimum doorway or aisle width clearance of 44" [1,100mm] is required for unit to pass through when maneuvering it to the installation site.

IMPORTANT!

Installation is the sole responsibility of the customer, unless previous agreements have been made in writing.

Damage to appliance, or accessories, caused by poor work practices or improper use of material handling equipment shall not be covered by the factory Warranty.

Giles shall not be liable for personal injury or property damage which may be incurred during installation of this equipment.

2.3 Electrical Requirements

CAUTION

- Fryers must be properly grounded in **accordance with local code, or in the absence of local code, with the National Electrical Code, ANSI/NFPA 70**. Improper grounding may expose users to an electrical shock hazard. Check local electrical code to ensure that proper grounding practices are employed.
- Always consult a certified electrician, or qualified service technician, prior to installation to ensure that electrical circuits are of sufficient rating to supply the appliance load.
- The **GBF-70** fryer is manufactured for various electrical specifications as shown in **Table 2.4**. Check the serial/data label inside the cabinet, or attached to rear panel, to determine the proper electrical service required. **Each unit of a banked battery requires a separate power service.**

2.4 Electrical Specifications: Single & Banked (per Fryer Unit)

Voltage	Ph	Hz	Watts	Amps		Breaker Size
				Unit powering pump	Unit without pump	
208	3	60	19,950	57	55	70
240				50	48	60
480				26	24	35

2.5 Electrical Connection

NOTE:

All electrical materials (breakers, conduit, wire, hardware, etc.) and labor necessary for electrical installation shall be supplied by the customer. All work should be performed by a qualified professional electrical contractor and must comply with all local building code requirements.

Giles shall not be responsible for code compliance in regard to installation and use of this appliance.

- As needed, install appropriate circuit breaker(s) in the main electrical panel. See **Section 2.4**.
- It is recommended** that a disconnect switch box be installed between main panel and appliance as a *service disconnect*.
- See **Figure 2.5.1**. Connect 1-1/4" flexible conduit from electrical panel (or disconnect switch) to the fryer. Route conduit through rear panel to the back side of the fryer service box and attach with appropriate conduit fittings and connectors. Allow enough length so that unit can be moved sufficiently for cleaning or service.
- See **Figure 2.5.1**. Open the cabinet and remove service box cover.
- Connect ground wire between ground lug and proper earth ground.
- Route appropriately sized power supply wiring from the main panel (or disconnect switch) through to the front service box.
- See **Figure 2.5.1**. Connect the supply power wires to distribution block inside service box and reinstall cover.
- Banked fryer system installations, require that each fryer in the battery be connected as explained above.**

2.5.1 Electrical Connection Diagram

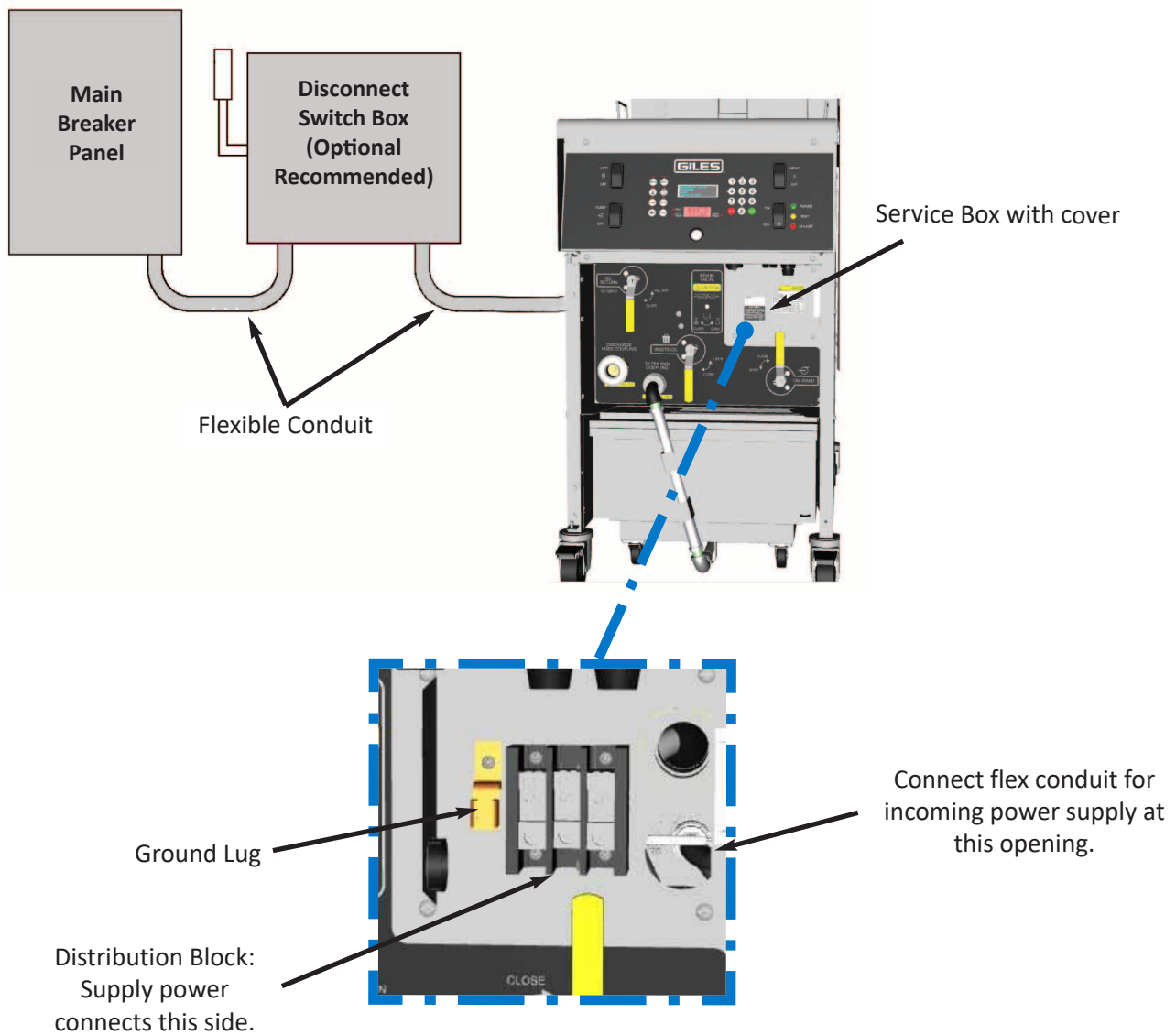

Each fryer unit in a banked battery system requires a completely separate electrical service, connected in like manner.

2.6 Ventilation

NOTE:

Guidelines and code requirements for ventilation in commercial cooking establishments can differ from locale to locale. Always consult the local **Authorities Having Jurisdiction (AHJ)** to ensure compliance.

Consult a professional ventilation or HVAC contractor for assistance in determining whether existing systems are sufficient to accommodate this equipment, or in designing a ventilation hood system that will comply with particular code requirements in your particular location.

2.7 Fryer Options - Added to Purchase

2.7.1 Bulk Oil Management System Connections

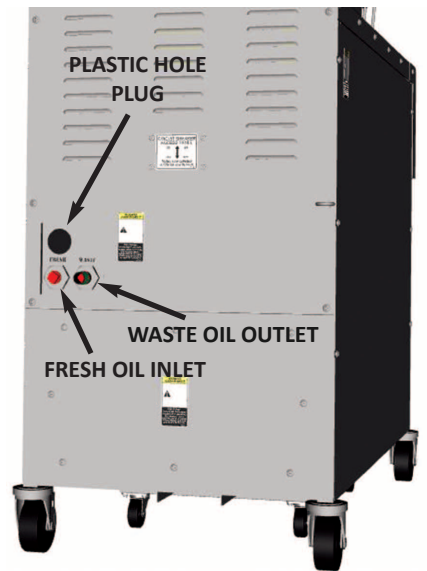

- Fryer equipped with this option is ready for connection to a **customer supplied bulk Oil Management System** ... either **fresh oil**, **waste oil** or **both options** may be purchased. Based on the option specified, either one or both connections are provided on the rear of unit ... **fresh oil inlet** ... **waste oil discharge outlet**. All appropriate valving and plumbing is factory-installed. Banked units have single connections, which service all units.

When connecting fryer to a *bulk oil system*, closely follow installation guidelines and instructions provided by the system's manufacturer.

- The external pump on a *bulk fresh oil supply system* must be wired into a pushbutton switch on the fryer control panel. Wire leads for connection of this switch are secured to the *plastic hole plug* inside the rear panel ... remove plug to access the wiring.
- Use quick-coupling fittings, as needed, to facilitate disconnection for cleaning and service activities.

IMPORTANT!

All materials (pipe, fittings, electrical, etc.) and labor expense necessary for connecting the appliance to a Bulk Oil System is to be provided by the customer ... not included with the purchase of these options.

2.7.2 On-Board Oil Top-Off System



- **Single Fryer:** Utilizes a removable "saddle-bag style" storage tank ... hangs on fryer side and connects via a flexible hose to the *fresh oil inlet* on rear of unit. Fresh oil supply in the tank must be manually maintained by the operator. An **[OIL FILL]** push-button switch on control panel controls a top-off pump to pump oil from tank to the cook vat. Tank has a lid to protect oil stored in tank from contamination



- **Banked Fryer system:** Utilizes a *jug-in-box (JIB)* concept. A purchased jug of fresh oil is placed directly in the cabinet. A dip tube connected to the top-off pump replaces the jug's cap to pump oil directly from jug to the vat. Same **[OIL FILL]** push-button switch on the control panel controls the top-off pump. When empty, simply replace jug with a fresh one.
- When option is selected, system is completely factory-installed and ready to use.

2.8 Restraint Device (Not Included)

Some code officials may require that the fryer be equipped with an appropriate *restraint device* that will prevent excessive movement, which could place excessive strain on electrical connections. The length of the restraint must be shorter than the length of wiring providing power to unit and it must be anchored to an immovable wall or structure. To allow easy disconnection for maintenance or service, a quick-release latch should be used on the cable to connect to factory-installed eye-bolt(s) on the rear of the unit. A restraint will be required at each end of a banked fryer system.

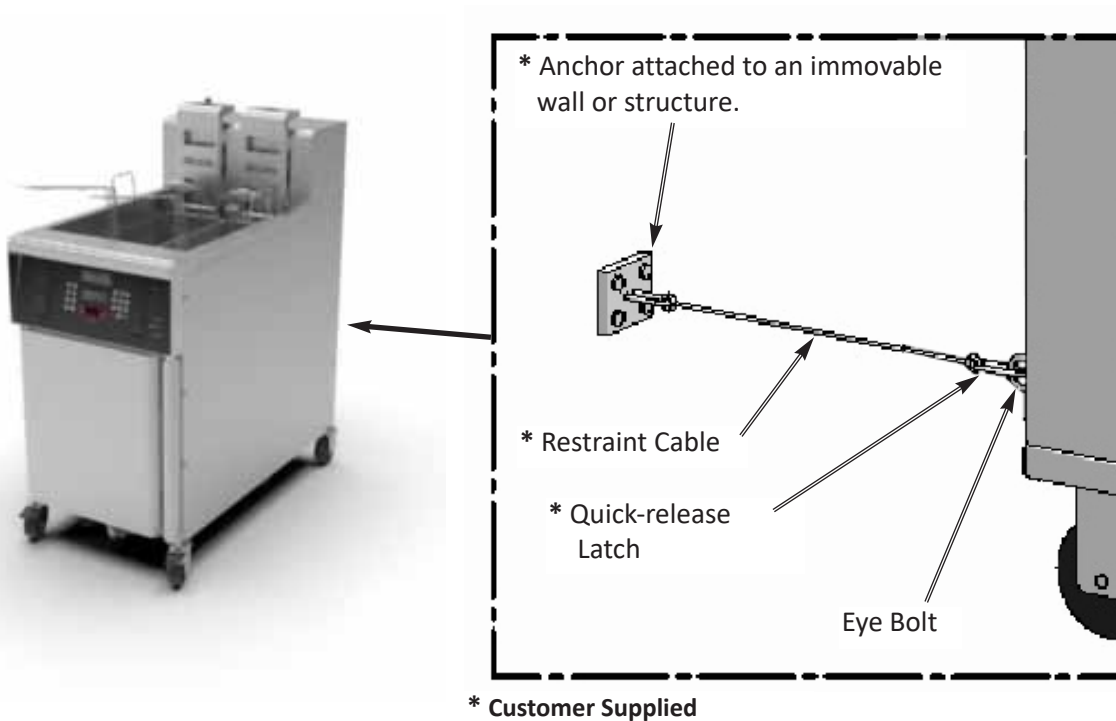

2.9 Finalizing Installation

Every effort is made to ensure that new *GILES* equipment is in perfect operating condition when received; each unit has passed rigorous quality control testing prior to shipment. To ensure that it has been properly installed and will operate as expected when placed into service, we recommend that after installation is completed, the following steps be completed to check basic functionality of fryer systems and prepare the appliance for its first use.

CAUTION

Before proceeding, please refer to *Section 3* and become familiar with various fryer controls, systems and functions. After fully becoming familiar with that information, follow the following steps precisely to avoid possible equipment damage or malfunction.

2.9 Finalizing Installation - continued

BEFORE BEGINNING:

- Perform the tests on each unit of a banked system.
- As necessary, remove baskets, crumb/support screen and filter pan from fryer.
- As applicable, on control panel(s) set switches (*POWER, HEAT, PUMP, LIFT*) in the [OFF] position
- Confirm that drain valve(s) are [CLOSED].
- If any of these tests fail to produce indicated results, consult **Section 6, Troubleshooting**, or contact **GILES Technical Service at 800.554.4537** for assistance.

2.9.1 Power Test

The following test confirms that the unit is properly receiving power. Perform test for each unit in a banked system.



1. Confirm that circuit breakers supplying power to unit are ON. If disconnect switch box is installed between the main panel and fryer, be sure that it is in the ON position.
2. Place the **POWER** switch in the [ON] position. The green **POWER** light will turn ON. After controller powers up, the alarm sounds. Press the [ALARM] key to silence, leave power ON and proceed to **Section 2.9.2**.

If the **POWER** light does not turn ON and/or controller does not power-up, refer to **Section 6.1, Troubleshooting Procedures**.

2.9.2 Heat Test

This test confirms that heating elements are powered and being properly energized by the controller. Perform test for each fryer unit in a banked system.

⚠ DANGER Heating elements become extremely hot when energized! Skin contact will result in severe burn injury.

1. Confirm that **HEAT** switch (2) is in the **[OFF]** position and drain valve is completely **[CLOSED]**.
2. Liberally dampen heating elements (1) with a wet sponge or towel ... leave visible moisture on them.
3. The controller displays (3) should show the messages **"POWER FAILURE PRESS [START] TO PREHEAT"** on the *upper screen* and **"HOLD"** on the *lower screen*. Press the **[START]** key (4).
4. The *upper display* should change to show a temperature setpoint **>300°F** along with the message **PREHEAT**. The small red **HEAT** indicator on controller beside *lower display* will turn ON and real-time temperature is displayed on the *lower display*. The control panel amber **HEAT** light (5) should **NOT** be ON.
5. Place the **HEAT** switch (2) in the **[HEAT]** position. The **HEAT** light (5) should now turn ON. Only leave switch for **NO MORE THAN 15 to 20 SECONDS** then return it to the **[OFF]** position.
6. The moisture on elements should dry quickly and heat should be felt rising from the vat. **DO NOT TOUCH HEATING ELEMENTS!**
7. If heating elements do not dry reasonably quickly (15-20 secs) or heat is not detected, refer to **Section 6.1, Troubleshooting Procedures**. Otherwise, proceed to **Section 2.9.3**.

NOTE: During this test, if the **HEAT** light turns OFF, the alarm sounds and an error message **"ERROR - MAX ELEMENT TEMP"** or **"ERROR - LOW OIL LEVEL"** return **HEAT** switch to **[OFF]** and proceed on to the next step, as this will be an acceptable indication that elements have been properly powered.

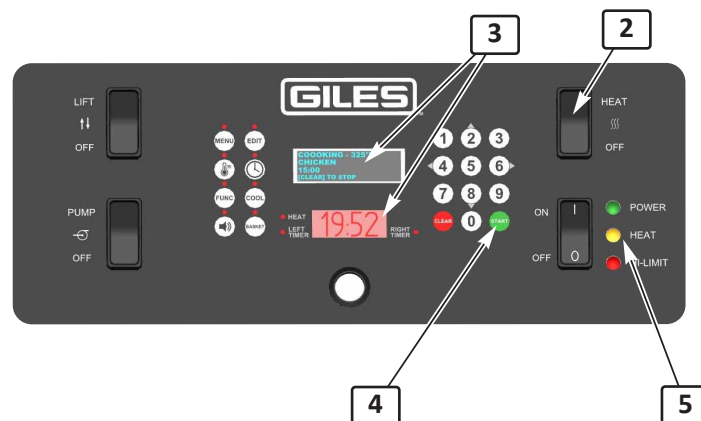
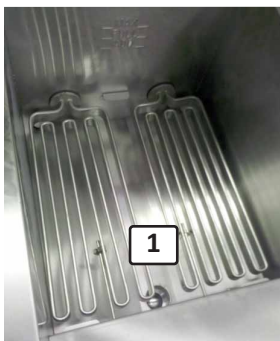

2.9.3 Filter Pump Test

The following test confirms that the filter system pump is operating properly.

1. Open cabinet door (*unit with filter pan on banked system*). If needed, disconnect and remove the filter pan from the unit.
2. Place the **OIL RETURN** valve ① in the **[FILL POT]** position (horizontal).
3. Firmly press the palm of the hand over the **filter pan coupling** ② on the front brace.
4. While covering the opening with the hand, place the **PUMP** switch ③ in the **[PUMP]** position. The filter pump will start ... if suction is felt, it is operating correctly. Return switch to **[OFF]**. Allow pump to **ONLY** run long enough to check for suction.

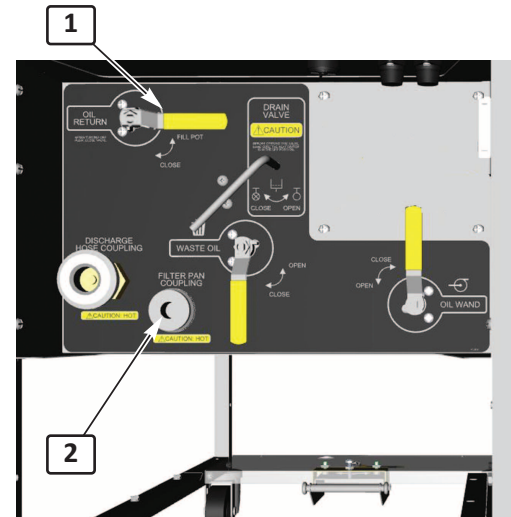

OIL TOP-OFF PUMP (if equipped):

5. If the unit is equipped with the *optional* on-board *Oil Top-Off system (not bulk oil)*, press and momentarily hold the **OIL FILL** push-button ④ on the control panel. You should hear the top-off pump start to run. Release the button and the pump should stop.

If either pump does not run or suction is not detected at the filter pan coupling ②, refer to **Section 6.2, Troubleshooting Procedures**. Otherwise, proceed to next section.

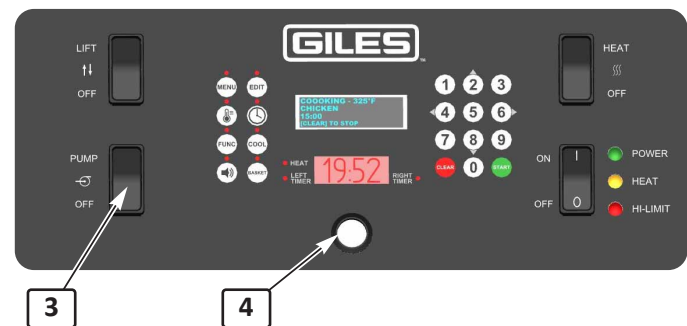

2.9.4 Initial Fryer Cleaning (Boil-Out Procedure)

IMPORTANT!

Before using the appliance for the first time, it is necessary to perform a *Boil-Out Procedure* (for all units of a banked system). This process will remove residue which may remain from manufacturing processes, or dirt and debris that may have accumulated during warehousing and shipment. For details concerning the Boil-Out Procedure see *Section 5.1*.

2.9.5 Clean Filter Pan, Accessories & Appliance

Disassemble and thoroughly clean all parts of the filter pan to remove residue which may remain from manufacturing processes, or dirt and debris that may have accumulated during warehousing and shipment. For details, see *Section 5.2, Cleaning the Filter Pan & Refreshing Filter Media*.

Wash all of the accessory items included with the fryer (cooking baskets, basket carriers, screens, utensils, tools, etc.) in warm soapy water, rinse and dry thoroughly.

Inspect unit for any adhesive plastic protective film which may remain on sheet metal surfaces. Some film is typically left in place as protection during storage and shipment. Remove all such material and clean the entire exterior of the unit with a good quality stainless steel cleaner/polish. **DO NOT use cleaners that are abrasive or contain caustic chemicals.**

2.9.6 Optional KITCHENTRAC® Remote Equipment Monitoring



If your new equipment is factory-equipped with **optional Giles' KITCHENTRAC™** remote monitoring, an account must first be created before the feature can be used. A monthly server hosting fee (*per controller monitored*) is required to use the service.

After appliance installation is complete and an account has been created, the appliance must be connected to the establishment's local *wifi network* and subsequently to the **KITCHENTRAC™** server. A wireless router which provides a continuous open connection to the internet and is located within range of the monitored appliance, is required.

A detailed **WiFi Connection Manual (Form #66313)** should have been packed with the unit. Before the monitoring service is active, the steps outlined in that manual must be completed. If you have purchased a banked system, the set up procedure must be performed for each controller. **Appendix A** in the back of this manual also explains the connection & pairing process.

Once the connection process has been completed, you will be able to monitor appliance performance, productivity, menu trends, operational status, etc. and access the available analytics by simply logging-in to the **KitchenTrac™** website from any computer or remote device (smart-phone, laptop, or tablet).

Installation is now complete and the appliance is ready for use. Please carefully read the remainder of this Manual to become familiar with all controls, functions, operational procedures, and necessary maintenance procedures before attempting to use the appliance for the first time.

3. Overview

A brief overview of the components, features and accessories associated with the *Giles GBF-70 Electric Fryer*. Please review this section completely before using the appliance.

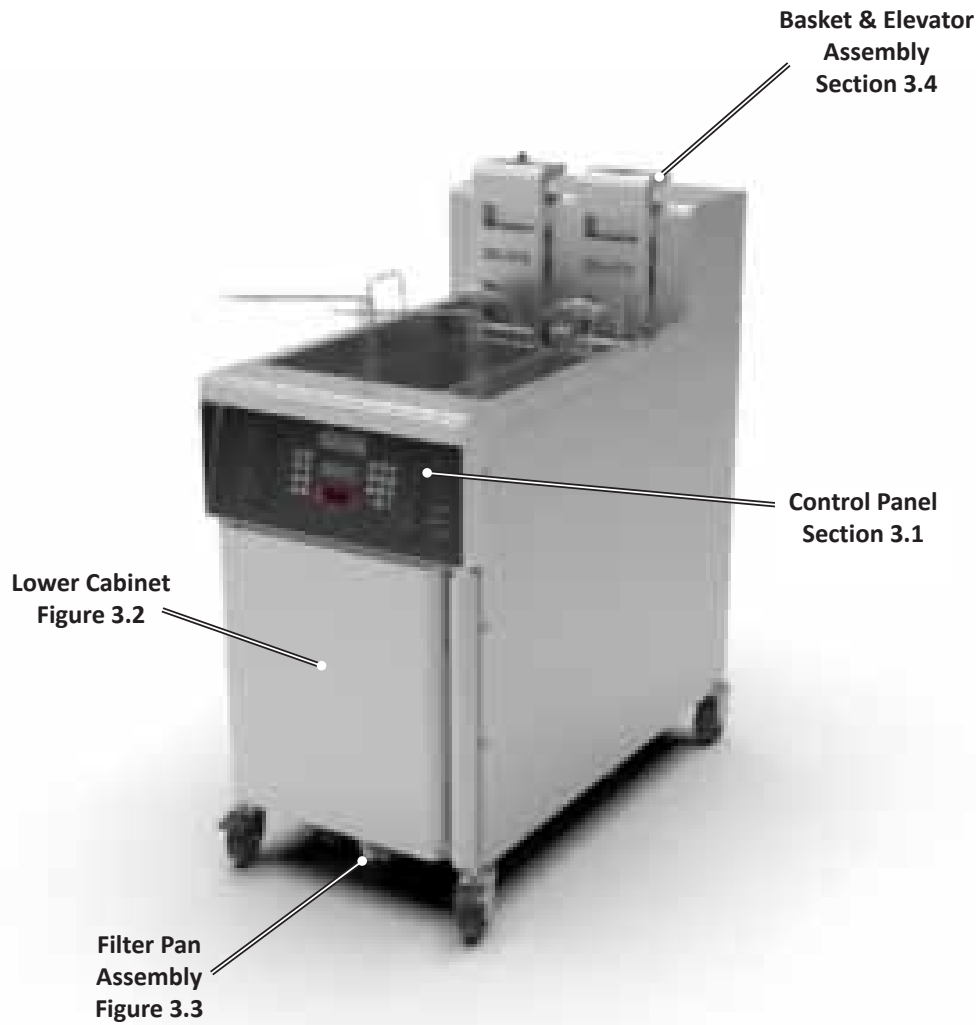

3.1 Control Panel



3.1 Control Panel - continued

Item	Description	Function
1	POWER Switch	Turns appliance power ON/OFF. Pressing top of switch turns power ON, pressing bottom turns power OFF.
2	HEAT Switch	Place switch in [HEAT] position to enable heating elements. If actual oil temperature is lower than the controller setpoint, elements will be turned ON and cooking oil will begin heating. When in the [OFF] position, elements are disabled and will not turn ON.
3	Computer Controller	Regulates cooking oil temperature and controls cooking time. Features fifty (50) programmable menu item cooking presets, Boil-Out program, Force Filter function, Auto-Cool Mode , password control & multi-language selection. Monitors fryer operation, displays error/alarm message and operational instructions.
4	POWER Indicator Light	Green light illuminates when the appliance POWER switch is in the [ON] position.
5	HEAT Indicator Light	Amber light illuminates to indicate that heating elements are energized and heating the oil. The light cycles ON & OFF while cooking, as oil temperature is regulated by the controller.
6	HI-LIMIT Indicator Light	The red HI-LIMIT light illuminates to indicate uncontrolled overheating and that the high-limit safety thermostat has shut down heating elements. Should this light come on during operation, refer to the Section 6, Troubleshooting in this manual. DO NOT ATTEMPT TO COOK IN A FRYER WHEN THE HI-LIMIT LIGHT IS ON!
7	OIL FILL Control Switch (Optional)	Depending on fryer options purchased, switch activates either the <i>on-board top-off pump</i> or a pump in a customer-provided bulk oil management system to deliver fresh oil to a cook vat. <i>The switch position is plugged if not used.</i>
8	LIFT Switch (Optional)	Enables/disables automatic basket lifts. Lifts are active when in the [LIFT] position, they WILL NOT operate when switch is in the [OFF] position. <i>This switch is not installed unless fryer is equipped with optional basket lifts ... position is plugged if not used</i>
9	PUMP Switch	Turns filter pump ON & OFF when filtering cooking oil or removing waste oil from fryer. <i>On banked systems, this switch is present only on the unit containing the filter pan ... position is plugged if not used.</i>

3.2 Lower Cabinet

Main Unit

Banked Add-on Unit

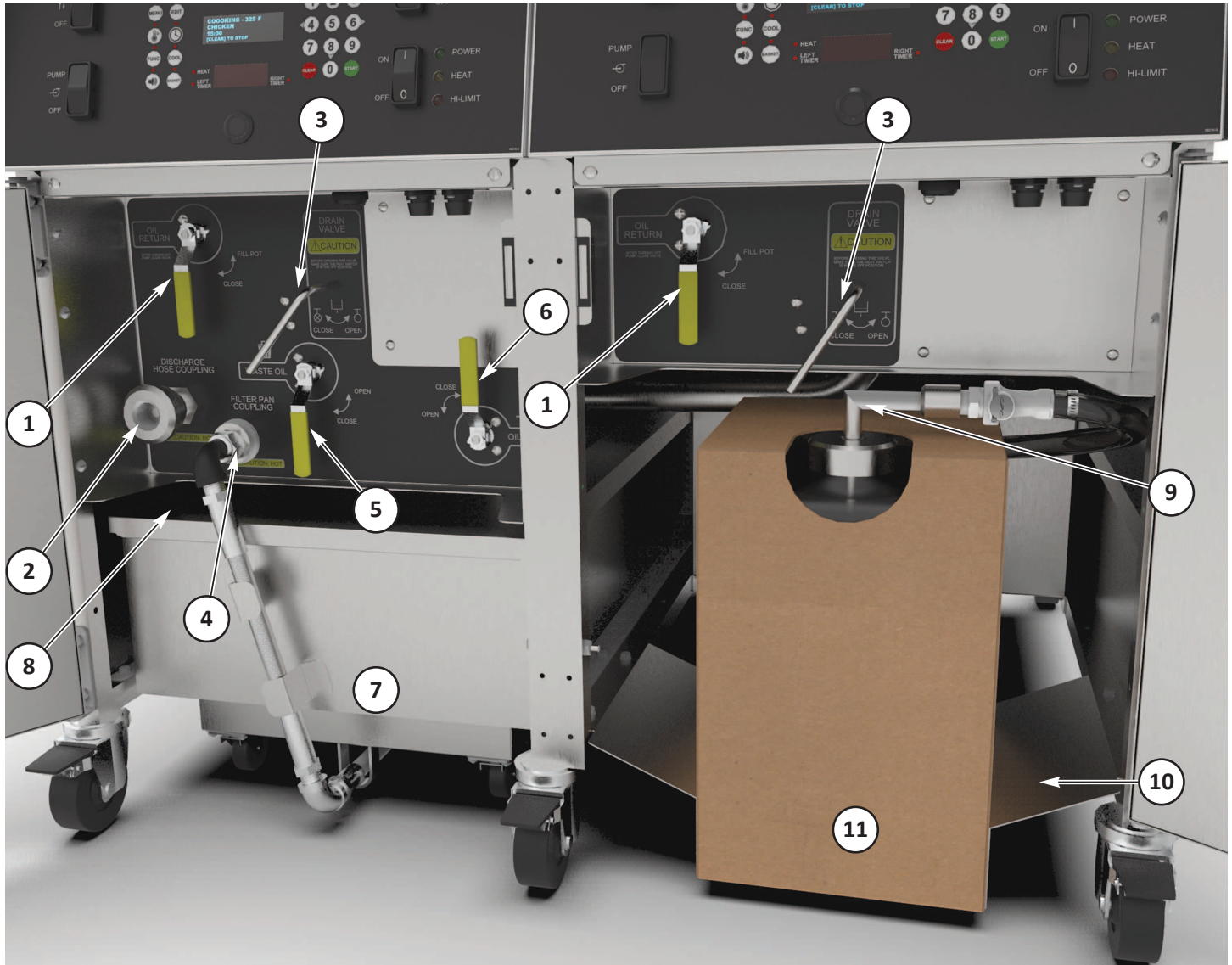

3.2 Lower Cabinet - continued

Item	Description	Function
1	OIL RETURN Valve	Directs oil flow to a particular vat from either the fryer filter pump, a bulk oil management system pump, or the oil top-off pump. THESE VALVES SHOULD REMAIN CLOSED UNLESS IN USE.
2	DISCHARGE HOSE COUPLING	Connects the waste oil discharge hose to the filter system for pumping waste oil into a portable oil disposal container. On banked systems, the coupling is only present on the unit with filter pan.
3	DRAIN VALVE Handle	Operates the vat drain valve . Always ensure the valve is [CLOSED] before adding cooking oil or preparing for boil out. NOTE: Fryer will NOT heat unless valve is fully closed. Controller will issue an error/alarm and shutdown elements if opened while cooking is in progress.
4	FILTER PAN COUPLING	Connects the filter pan hose to the oil filtration system .
5	WASTE OIL Valve (OPTIONAL)	If fryer is connected to a third-party bulk waste oil collection system, opening this valve directs pump discharge to the waste oil collection system. This valve is not present unless the bulk waste oil option is installed.
6	OIL WAND Valve	Opening valve allows waste oil to be discharged through the waste oil discharge hose supplied with the fryer. Hose must be connected at coupling or pump will stall, which could damage pump seals.
7	Fryer Filter Pan	Collects used cooking oil drained from the fryer vat and contains oil filtering media. See Section 3.3 for additional detail.
8	Filter Pan Cover	Helps contain splash and splatter as oil is being drained into the filter pan to keep floor and cabinet interior cleaner. Also, helps to avoid possible contamination of oil while temporarily contained in filter pan.
9	J-I-B Suction Tube	Optional Jug-In-Box (J-I-B) Top-Off feature ... provides hands-free capability to easily maintain proper oil level. Suction tube is inserted directly into a purchased jug of fresh oil. As needed, oil is pumped from jug to the selected fryer vat. Available only for banked fryer system ... an oil saddle tank is used for single fryer, see Section 3.4.
10	J-I-B Shelf	Holds a standard size 33-lb Jug-In-Box of fresh cooking oil.
11	Fresh Cooking Oil Jug	Purchased container of fresh cooking oil (customer supply)

3.3 Filter Pan Assembly

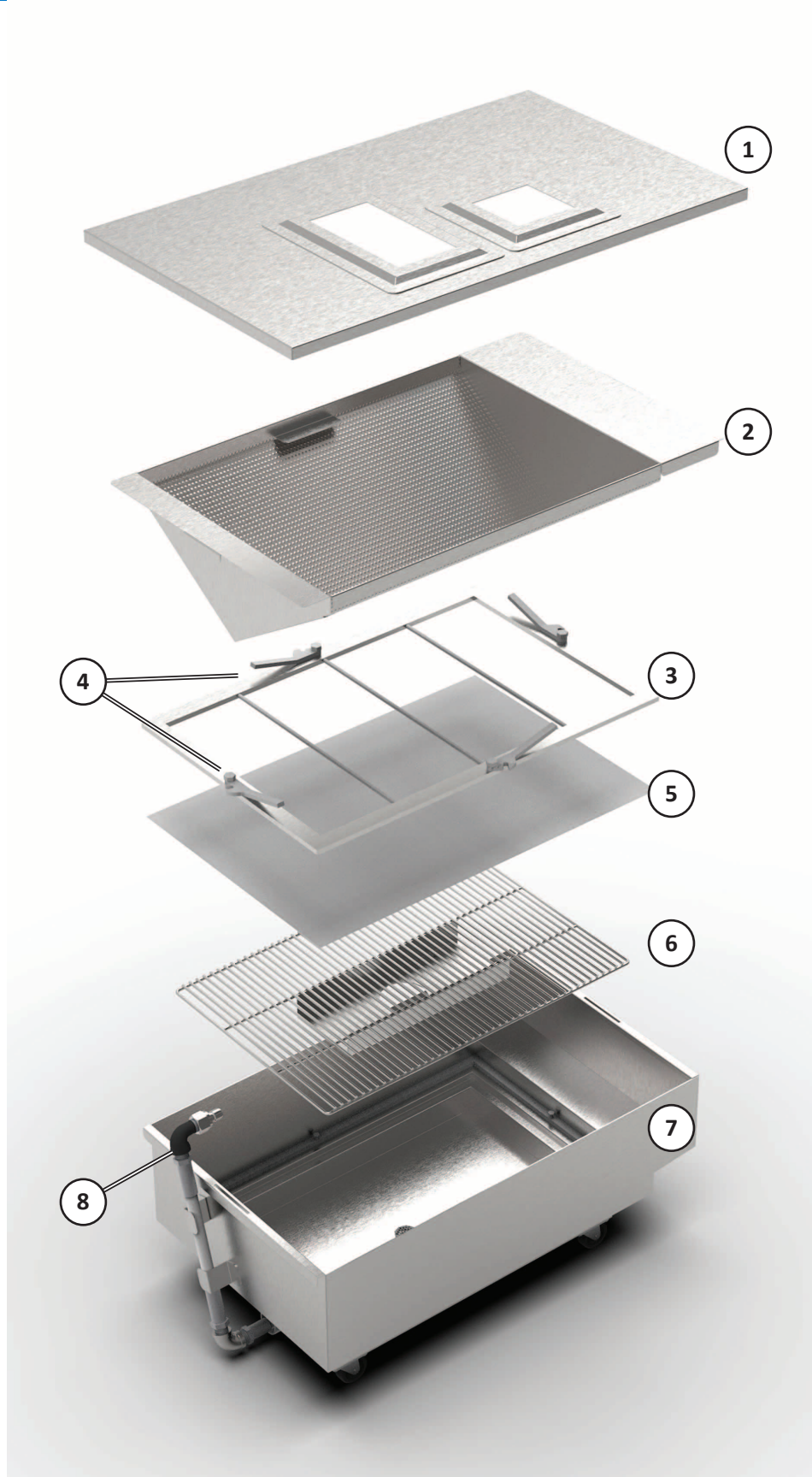

3.3 Filter Pan Assembly - continued

Item	Description	Function
1	Filter Pan Cover	Helps contain oil splash and spatter as oil is being drained into the filter pan from the vat(s) ... helps minimize clean-up required for floor and/or cabinet interior.
2	Crumb Screen	Filter pan insert designed to capture large breading crumbs and cooking residue as oil is drained from vat.
3	Hold-Down Frame	Secures filter media tightly against pan bottom to provide a good suction seal. Improper placement can result in poor filter pump performance.
4	Hold-Down Levers [4}	Locks hold-down frame in place. Failure to have these Levers properly engaged will potentially cause poor filter pump performance.
5	Filter Paper	Standard, disposable. paper filter media. Filters fine sediment and residue from cooking oil during the filtering cycle.
6	Filter Pan Screen	Supports filter media above the filter pan bottom..
7	Filter Pan	Collects used cooking oil for filtering or disposal; contains filter media which filters and reconditions oil during the filter cycle. Features casters and is removable for cleaning and changing of filter media.
8	Filter Pan Plumbing	Connects filter pan to the oil filtration system via quick-coupling fitting. Must be disconnected before pan can be removed.

3.4 Basket, Elevator Assembly, & Oil Saddle Tank

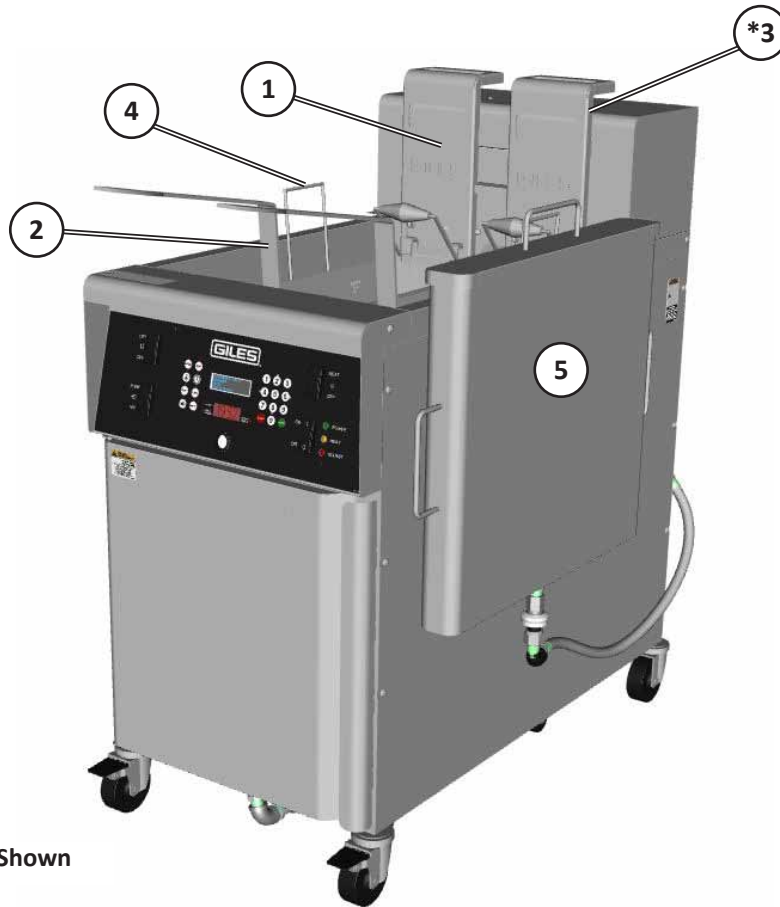

* Not Shown



Overview

3.4 Basket, Elevator Assembly, & Oil Saddle Tank - continued

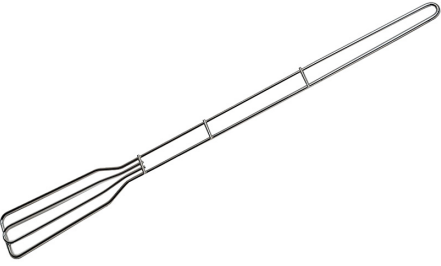

Item	Description	Function
1	Basket Carrier (2) (OPTIONAL)	Attaches to the auto-basket lift and holds basket in proper position as lift operates. Easily removed for cleaning.
2	Basket (2)	Contains product while cooking. Equipped with front spring handle for easier handling.
*3	Auto-Basket Lift (OPTIONAL)	Automatically lowers basket into hot oil and raises cooked product at the beginning and end of cooking time. Helps avoid over-cooking.
4	Fry Screen/ Basket Support	Placed inside vat to help prevent an excessive amount of cooking residue & crumbs from accumulating around the heating elements. When auto-basket lifts are not installed, the screen also serves as a support for baskets while cooking.
5	Removable Fresh Oil Saddle Tank (OPTIONAL)	<i>Single fryer only:</i> Hangs on fryer side and is manually filled with fresh oil by user. Provides oil supply for <i>Oil Top-Off</i> system. Easily removed, without tools, for cleaning. <i>Not used for banked fryer systems or when fryer is connected to a bulk fresh oil supply system.</i>

* Not Shown

3.5 Accessories Provided

Part	Description/Part Number	Function
	<p>Kettle Drain Brush P/N 71025</p>	<p>Use to clean excessive crumbs and residue from the vat drain tube.</p>
	<p>Stirring Utensil P/N 77775</p>	<p>Use to stir cooking oil and product in the pot as it is cooked.</p>
	<p>Pot Brush P/N 71100</p>	<p>Heat-resistant brush for cleaning vat sides.</p>
	<p>Crumb Shovel P/N 30059</p>	<p>Use to remove filter sediment from filter pan.</p>

3.5 Accessories Provided - continued

Part	Description/Part Number	Function
	<p>L-Bend Teflon Brush, P/N 93609</p>	<p>Use to clean under and around the heating elements.</p>
	<p>Cook Basket P/N 70420</p>	<p>Holds product while cooking.</p>
	<p>Fry Screen P/N 41445</p>	<p>Located in vat above the heating elements to prevent excessive accumulation of crumbs and cooking residue in the vat bottom around elements.</p> <p>Lifts out for cleaning.</p>



3.5 Accessories Provided - continued

Part	Description/Part Number	Function
	<p>Discharge Hose Assembly P/N 33667</p>	<p>Use for removing waste cooking from unit.</p> <p>NOT INTENDED TO USE FOR WASHING DOWN THE COOK VAT!</p>

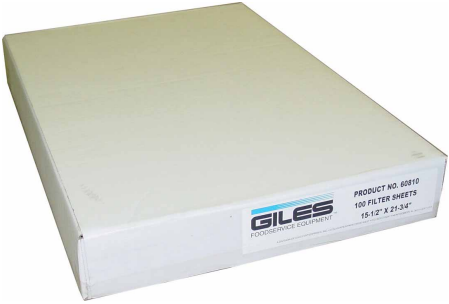

3.6 Accessories Not Provided

Part	Description/Part Number	Function
	<p>Giles Oil Caddy P/N 79187</p>	<p>A portable oil disposal container with capacity of 80-lbs of liquid shortening.</p> <p>Intended to handle only warm, filtered oil, containing no crumbs or debris.</p>

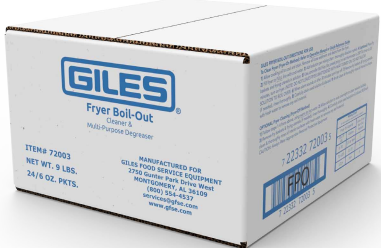
3.6 Accessories Not Provided - continued

Part	Description/Part Number	Function
	<p>Filter Paper P/N 60819</p>	<p>Filter media used in the filter pan for filtering cooking oil.</p>
	<p>Filter Powder P/N 72004</p>	<p>Filter aid for use when filtering cooking oil; helps recondition oil by removing soluble impurities.</p>
	<p>Giles Fryer Boil-Out P/N 72003 Case of (24) pre-measured 6-oz Packets</p>	<p>Fryer cleaner/degreaser ... add to water for a fryer boil-out cleaning procedure. Typical fryer requires (2) packets. Can be used as an overnight fryer cleaning soak. Also suitable for cleaning tile & concrete floors.</p>

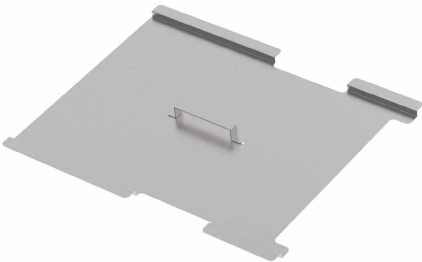
3.6 Accessories Not Provided - continued

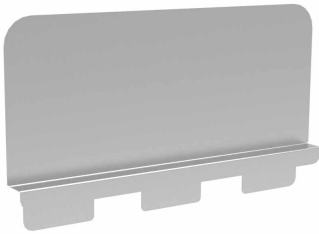
Part	Description/Part Number	Function
	<p>Pot Cover P/N 98995</p>	<p>Lid to cover oil in vat.</p>
	<p>Tool Caddy/Splash Shield P/N 72068</p>	<p>Tool storage & protection from splashing oil.</p>
	<p>Splash Shield P/N 72095</p>	<p>Protection from splashing oil.</p>

Notes:

4. Fryer Operation

The **GBF-70** fryer is manufactured as either a single unit or a banked system of (2) or (3) fryer wells and features a computer cooking controller. **Optionally**, units can be configured with convenient *Oil Level Top-Off* capability, which utilizes an on-board fresh oil supply (*jug-In-box or saddle tank*) or a customer-provided bulk oil management system. Fryer is standard with manual basket hanger racks ... **optional** *Auto-Basket Lifts* are available. Other option available is factory-ready direct connection to customer-provided *bulk oil management systems (fresh and/or waste)*. When becoming familiar with the operational procedures in this manual, be certain that you are referencing information or instructions pertinent to the specific fryer configuration you have.

When using a bulk Oil Management System, always follow the manufacturer's operating instructions.

⚠ DANGER

- Before cleaning or performing maintenance, turn **OFF** fryer power switch and power supply at main electrical panel.
- **DO NOT** wash down the fryer interior or exterior with water spray, or pressure washing equipment. Control panels are "liquid resistant", but are **NOT** washdown safe.
- Failure to comply with **DANGER** notices will result in serious injury - even death, damage to equipment and/or property, and will void the factory warranty.

⚠ WARNING

- **DO NOT** use or store flammable liquids or materials that produce flammable vapors in the vicinity of this or any other appliance!
- **DO NOT (or ALLOW OTHERS to) stand or step onto the top of the fryer for any reason.** Very serious injury can result from slips and falls, or from bodily contact with extremely **HOT** oil in the cooking vat (**excess of 330°F/166°C**). Removable covers often placed over cooking vats are **NOT designed to, and WILL NOT, support the weight of a person.**
- Failure to comply with **WARNING** notices could result in serious injury - even death, damage to equipment and/or property, and will void the factory warranty.



⚠ CAUTION

- Be sure the fryer is positioned in a stable, safe location with the casters in the locked position.
- Consult a professional electrician to be certain that all electrical specifications have been met and the unit is properly grounded. A wiring diagram is provided with the unit.
- Exercise caution when operating and cleaning. **To avoid personal injury, wear thermal protection (gloves or mitts) while tending the appliance.** Certain parts of fryer will become very **HOT** during operation; temperatures inside the cabinet may exceed **150°F/65.5°C and cooking oil temperatures will be in excess of 330°F/166°C.**
- This appliance is for professional use only and is to be operated by qualified personnel. It is not intended for use by persons (including children) with reduced physical, sensory, or mental capabilities, or those lacking experience and knowledge, unless they have been given adequate instruction and/or supervision concerning its operation by a person responsible for their safety. **DO NOT** allow children in the vicinity of this appliance.

4.1 Computer Controller

This section explains the functions, features, and programming and operating procedures for the dual-timer cooking controller. It has been designed to be user-friendly and when working with it many instructions and prompts will be shown on the **Upper Display** (blue) to help guide you through each process.



4.1.1 Keys & Functions



Numeric Keypad: Enter and edit fryer settings or *menu item* cooking presets.

Arrow Keys: [2 - 4 - 6 - 8] keys serve as directional & special function keys for selecting inputs, scrolling through lists, moving the cursor, etc.

2-UP • 8-DOWN • 4-LEFT • 6-RIGHT. The keys light up when active.

[START]: Function key to start various operations, select items, save settings, exit operations, etc.

[CLEAR]: Function key to cancel operations & functions.

4.1.1 Keys & Functions - continued



MENU Key: Action key which is pressed in combination with other keys to access programmed menu item presets. Fifty (50) different programmable presets are available.



EDIT Key: Action key which is pressed in combination with other keys to enter edit mode for changing or creating *menu item* preset settings.



TEMP Key: Press this key to set the cooking oil temperature setpoint. When fryer is in **READY** state, pressing key twice (2x) will display *actual oil temperature* on the *lower display screen* for approximately **20 secs**.
NOTE: During **PREHEAT**, actual real-time temperature is displayed.



CLOCK Key: Press this key to manually set a cooking time (mm:ss).



Pressing this key while controller is in **PREHEAT** begins the **BOIL OUT** program. Temperature setpoint and cook time change to **BOIL TEMP** and **BOIL OUT TIME** as set in **User Settings (Section 4.1.10)**. **Default = 200°F & 30 minutes**. **NOTE: Also opens a menu of automatic FUNCTIONS for the Automated version of the GBF-70 ... not yet in production, date TBD.**



Press this key to enter **COOL** mode. This energy-saving feature allows fryer to standby at a lower oil temperature during inactive periods. Setpoint changes to the **COOL TEMP** specified in **User Settings (see Section 4.1.10)**. **Default = 275°F**.

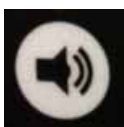

ALARM Reset Key: Pressing this key silences the controller alarm and acknowledges certain status messages. Alarm tone will silence automatically after a set amount of time.



BASKET Key: Activates arrow keys **[2 - 4 - 6 - 8]** for manually operating basket lifts. The key is disabled during **PREHEAT** to prevent lowering of food product into oil that is not at proper cooking temperature. **The key is inactive in fryers without basket lifts.**

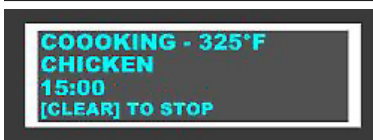

Upper OLED Display Screen (blue graphic): Displays various fryer information, operational prompts and user instructions.



Lower 7-Segment Display Screen (red graphic): Displays various information, timer countdown, temperature, error codes, etc.

[HEAT] indicator illuminates when the controller is calling for the heating elements to energize.

[LEFT/RIGHT Timer] indicators illuminate to show which basket timer is being displayed on the screen.

4.1.2 Controller - General Overview

The following is general operational information only. Detailed procedures and instructions are discussed in later sections. During operation, instructions and prompts will be shown on the *upper display screen* to help guide you through certain processes. Additionally, some controller keys and indicator lights will illuminate as a further aid.

- **POWER UP:**

Place **POWER** switch in **[ON]** position. Controller will power up and sound an alarm. The message **“POWER FAILURE [PRESS START TO PREHEAT]”** is shown on the *upper display screen*. ***This is normal***, intended to prevent the fryer from beginning to heat unattended, such as after power interruptions. Pressing the **[START]** key silences the alarm and places fryer into **PREHEAT** mode. If **HEAT** switch is in the **[HEAT]** position, and temperature setpoint is higher than the current actual oil temperature, heating elements will turn ON and cooking oil will begin to heat. ***DO NOT place HEAT switch in [HEAT] position unless vat is filled to the FULL level with cooking oil or water.***

- **PREHEAT:**

Oil is heating and real-time actual oil temperature will be displayed on the *lower display screen*. When oil reaches the programmed setpoint, the alarm will sound and *upper screen* will display the message **“ALARM - STIR OIL”**. At this time, press the **[ALARM]** key and vigorously stir cooking oil. Controller delays for 10 seconds ... typically, the oil temperature will drop when stirred and if temp drops below setpoint during the delay time, **PREHEAT** continues until it returns to setpoint. ***This process helps to ensure more consistent temperature throughout the total volume of oil, leading to better cooking performance.*** Upon returning to setpoint, alarm sounds again and *upper screen* shows **“ALARM - SETPOINT REACHED”**. Pressing the **[ALARM]** key places fryer into **READY** state.

- **READY STATE:**

Fryer is ready for cooking. The *lower screen* changes to display the current controller temperature setpoint. The last cook settings used will be shown on the *upper display screen*.

While fryer is in **PREHEAT** or **READY** state, you may change cook settings either by selecting a different *menu item preset*, see **Section 4.1.5.2, Selecting a Menu Preset** • OR • manually inputting different settings (time and/or temp), see **Section 4.1.3, Setting the Cooking Temperature & Section 4.1.4, Manually Setting the Cook Time**.

NOTE: If PASSCODE ENABLE is set to ON, you cannot manually set a different cook time without entering the proper password. This lockout feature provides a measure of control over cooking procedures.

- **START:**

The current cook time setting for each basket side is shown on the *upper display*. To start a cooking cycle press the **[START]** key + select side: **[4]=Left, [6]=Right, [5]=Both**. When the selected timer starts, the cook cycle countdown appears in the *lower display*.



+

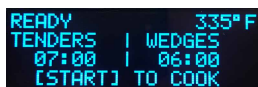

+

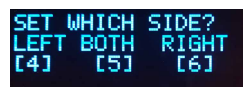

4.1.3 Setting the Cooking Temperature

Cooking temperature setpoint **must** be input manually, as ***menu item presets do not include temperature settings.*** Instruction prompts will be shown on the *upper display* to help guide you through the process.

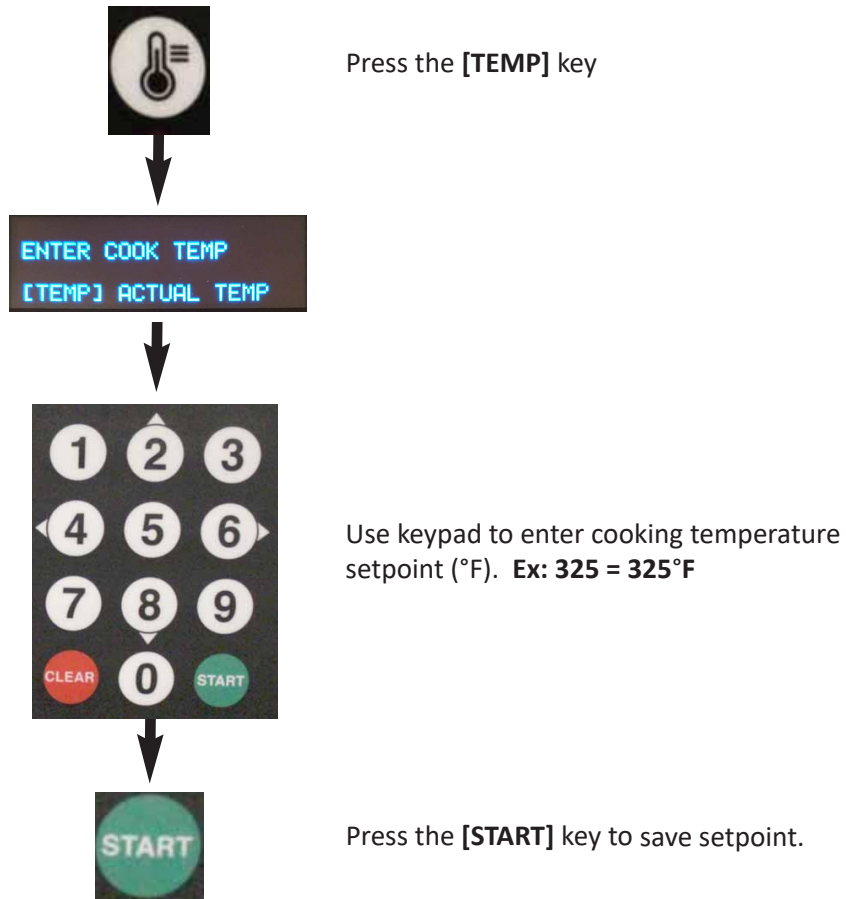

WARNING

DO NOT place HEAT switch in the [HEAT] position unless vat is filled to [FULL] level with cooking oil or water.

- If actual oil temperature is lower than the entered setpoint, controller enters **PREHEAT** (*small red HEAT indicator beside the lower display screen turns ON*). Before oil will actually begin heating, the control panel **HEAT switch must be placed in the [HEAT] position**. The amber control panel **HEAT** indicator light will turn ON and oil begins heating.
- If actual oil temperature is already **equal to or greater than** the entered setpoint, the alarm sounds and message **"SETPOINT REACHED"** is displayed. Press the [ALARM] key to enter **READY** state. Fryer is ready for cooking.

While heating, real-time actual oil temperature is shown on the *lower display screen*. After reaching setpoint, the display will change to show the **setpoint temperature** instead of actual temperature.

NOTE:

Pressing the [TEMP] key twice (2x) will display actual oil temperature for 20 seconds. Default unit for temperature is [°F] ... it can be changed in **Section 4.1.10, User Settings**.

4.1.4 Manually Setting the Cook Time

IMPORTANT!

If **PASSCODE** is enabled, cooking time **cannot** be manually input without entering the required password. Without a password you will be restricted to only choosing from the available **Menu Item Presets**, see **Section 4.1.5, Working with Menu Presets**.

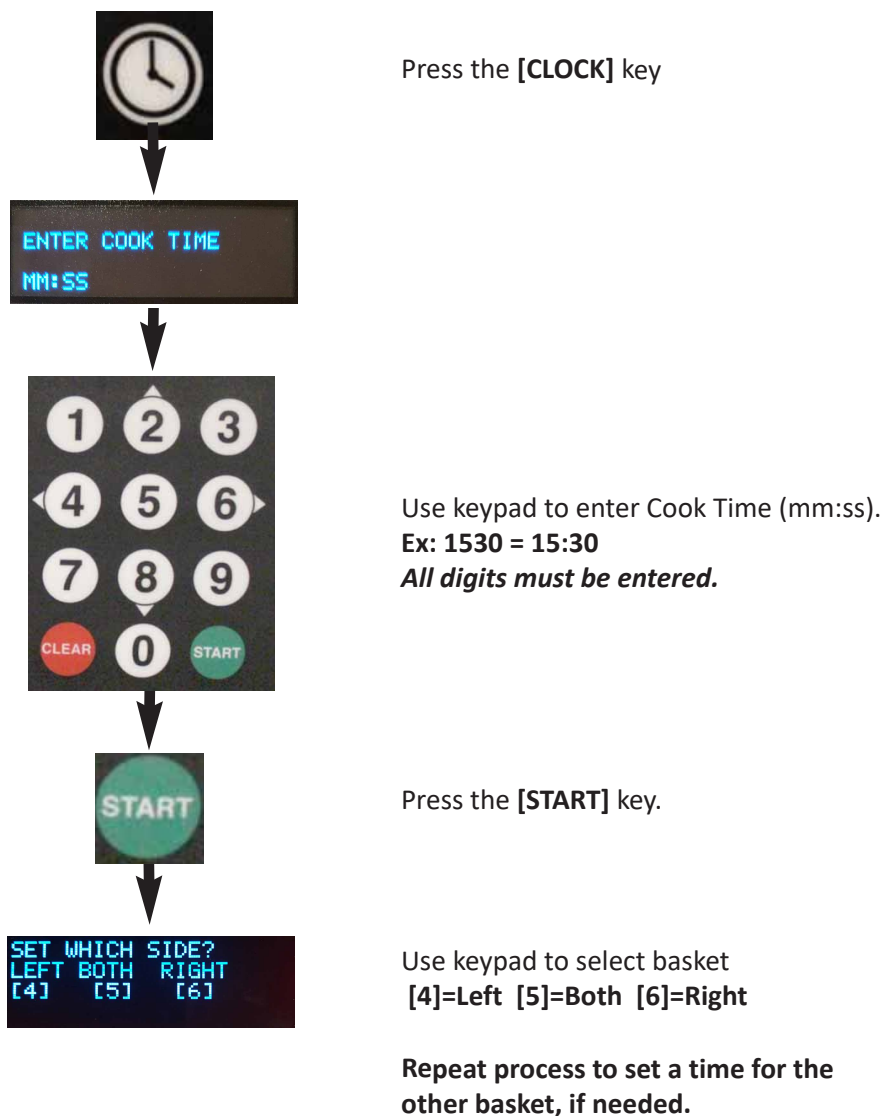

NOTE: *Menu Presets* include a **Name** which is displayed on the *upper display* when selected. When a cooking time has been manually input, the displayed name will be [MANUAL] instead of a food item name.



4.1.5 Working with Menu Item Presets

NOTE:

Menu Item Presets stored in the controller **do not** include cooking temperature settings. Temperature must always be input manually, see **Section 4.1.3, Setting the Cooking Temperature**.

Fifty (50) **Menu Item Preset** cook settings are stored in the controller. Each includes:

- **Menu #** - Sequential ID number
- **Menu Name** - Name of the food product assigned to the preset.
- **Cooking Time** - Time setting for cooking the product.
- **STIR OVERRIDE** - Overrides the controller global **STIR ALARM** setting specified in *user settings* for this menu item. **Factory default = [NORMAL]**.
- **FISH FILTER** - To prevent flavor transfer, establishments cooking seafood products can force oil filtering after cooking only **one (1) batch** of a product. The setting overrides the global **FORCE FILTER** setting specified in *user settings*. **Factory default = [OFF]**. A **SNOOZE** feature is available that will allow **two (2) batches** to be cooked before forced filtering.

All the presets are factory-programmed with default settings. The first ten (10) are set for some popular menu offerings as shown below. All others contain general settings as shown on the last line of the table. You can edit any of these presets as needed to customize for your specific needs.

MENU NO.	MENU NAME	TIME (MM:SS)	STIR OVERRIDE	FISH FILTER
1	BONE-IN-CHICKEN	13:00	NORMAL	OFF
2	TENDERS	7:00	NORMAL	OFF
3	WEDGES	6:00	NORMAL	OFF
4	BONE-IN-WINGS	8:00	NORMAL	OFF
5	BONELESS WINGS	7:00	NORMAL	OFF
6	POPCORN CHICKEN	3:00	NORMAL	OFF
7	LIVERS	4:00	NORMAL	OFF
8	CORNDOGS	10:00	NORMAL	OFF
9	CHEESE STICKS	3:00	NORMAL	OFF
10	FISH	3:00	NORMAL	OFF
11 thru 50	MENU XX	2:00	NORMAL	OFF

4.1.5.1 Editing a Menu Item Preset



Press the [MENU] key twice (2x).

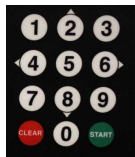

Use arrow keys [2] UP • [8] DOWN to scroll through list to the desired menu preset to edit.



Press the [EDIT] key to select & display the current settings.

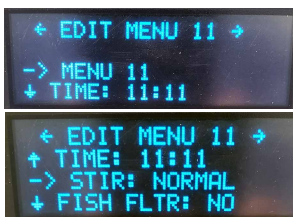

Use arrow keys [2 - 8] to move the cursor [-->] until it points to the preset item you wish to edit:

- [NAME]
- [TIME]
- [STIR OVERRIDE]
- [FISH FILTER]

Press [START] to select the item.



Press the [START] key to begin edit.

Edit NAME: Two methods available

Method 1

Enter NAME letter by letter

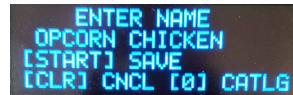

Choose **NAME** setting as described at the left. A flashing cursor will appear at the first letter of the current **name**. Use arrow keys [2 & 8] to scroll thru alphabet ... the character at cursor changes ... stop on the desired letter. Press right arrow key [6>] to move cursor to next character in the **name** ... repeat until entry is complete.



When finished editing, press [START] to save

- OR -

Press [CLEAR] to Cancel & Exit without saving



Use left arrow key [<4] to backspace and erase errors.

Method 2

Select a NAME from catalog of programmed names.

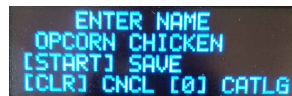

Choose **NAME** setting as described at the left. Cursor appears at first letter. Press [0] key to open a **catalog** of **programmed names** ... use arrow keys [2 & 8] to scroll through list. Stop at desired **name** & press [START] to copy the selected name to the item being edited. The previous display returns.

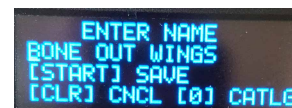

When finished, press [START] to save - OR - Press [CLEAR] to Cancel & Exit without saving - OR - Press [0] to re-open the **name** catalog.

4.1.5.1 Editing a Menu Item Preset - continued

Edit COOKING TIME:

After entering EDIT, select TIME to edit as shown on previous page.



Current time setting is displayed.

Using numeric keypad enter new TIME (mm:ss)

NOTE: All digits must be entered, e.g. 500 = 5:00.

While entering time, [CLEAR] key will backspace to remove an incorrect entry.

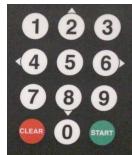

After entering new TIME value press [START] to Save

• OR •

Press CLEAR to exit without saving



Edit STIR OVERRIDE Setting:

Regardless of the global **STIR ALARM** setting in *user settings (Section 4.1.10)*, you may want to have a menu item stirred or not stirred during the cook cycle. The **STIR OVERRIDE** setting overrides the global setting for a menu item. The options are [NORMAL] • [SKIP] • [FORCE].

[NORMAL] = alarm is issued as specified.

[SKIP] = alarm is **NOT** issued for this item, regardless of global setting.

[FORCE] = alarm is **ALWAYS** issued for this item, regardless of global setting.

Factory-default = [NORMAL]

To edit the **STIR OVERRIDE** setting, select [STIR] as described previously ... [→] points to [STIR]



Press the [START] key to toggle between the selections and stop at choice.

4.1.5.1 Editing a Menu Item Preset - continued

Edit FISH FILTER Setting:

To minimize potential for flavor transfer, establishments that cook seafood may wish to force operators to filter oil after only cooking **one (1) batch** of a product. When **FISH FILTER** is set to **[ON]**, the unit will enter **FILTER MODE** after completing one load of a specific item. If **FORCE FILTER SNOOZE** is set to **[ON]** in **user settings (Section 4.1.10)**, an additional load may be cooked before filtering is forced. When **FORCE FILTER = [OFF]** only a filter warning message is displayed on the *upper controller screen* ... when **FORCE FILTER = [ON]**, the fryer is locked out until a filter cycle is completed.

To edit **FISH FILTER** setting, scroll to and select **[FISH FLTR]** as described previously ... **[→]** points to **[FISH FLTR]**



Press the **[START]** key to toggle between the selections and stop at choice.

Exit EDIT function:

After completing and saving edits to a *Menu Item Preset*, press either the **[CLEAR]** key or the **[EDIT]** key to exit that preset. The arrow keys **[2 - 8]** remain active and can be used to scroll to a different preset to edit.



Press the **[CLEAR]** key again to completely exit **EDIT**.

4.1.5.2 Selecting a Menu Item Preset for Cooking

Direct Entry: If you know the *menu no.* of the item that you want to cook, either of the methods below can be used to select it.

Method (A)



Method (B)

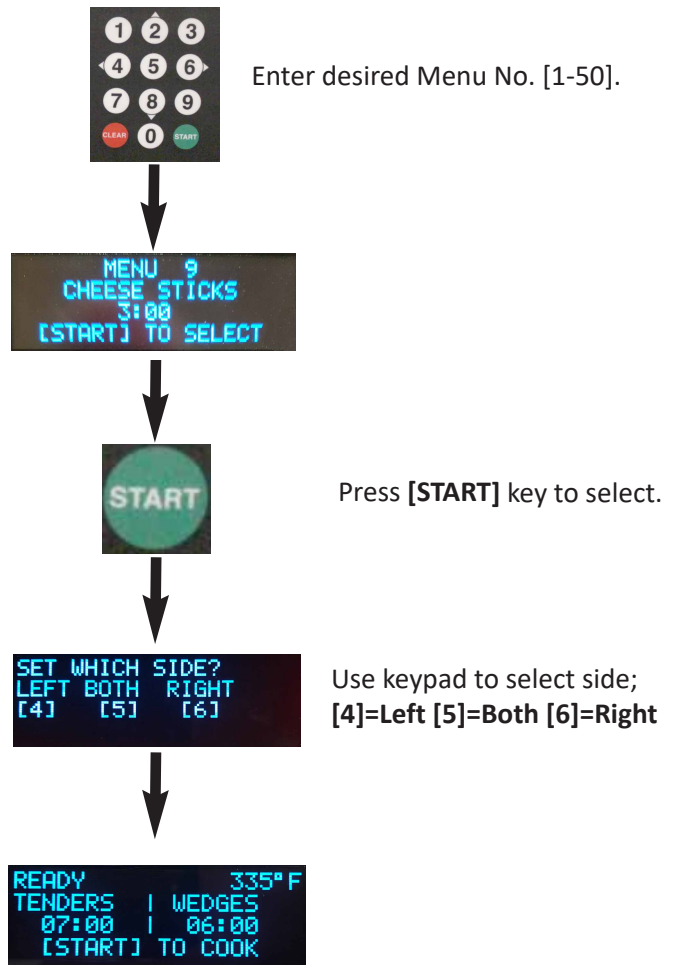

NOTE:

- If the user setting **“COOK ON MENU SELECT”** is set to **[ON]** and fryer is in **READY** mode, it will automatically enter **COOK** mode as soon as the *basket* is selected. Cooking time will begin counting down on *lower display screen*.
- If the setting is set to **[OFF]** (*default*), the cooking cycle must be started as explained in **Section 4.1.6, Cooking Cycle General Overview**.

4.1.5.2 Selecting a Menu Item Preset for Cooking - continued

Scroll Method: If a menu no. is not known, you can scroll through the list of **Menu Presets** to select the desired item ... the current settings will appear on the *upper display screen*.



Press the [MENU] key twice (2x)



Use numeric keypad [2] • [8] (up/down) to scroll through list to find the desired menu item.



Press [START] key to select.

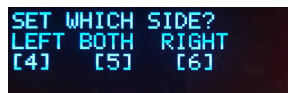

Use keypad to select side
[4]=Left [5]=Both [6]=Right

If the fryer is in **READY** state, cooking can be started; see **Cooking Cycle General Overview (Section 4.1.6)**.

4.1.6 Cooking Cycle General Overview

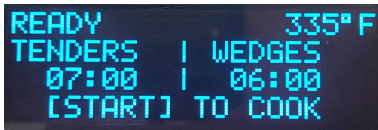

TEMP SETPOINT, MENU NAME & COOKING TIME currently assigned to each basket are shown on the *upper display screen*.



When in **READY** state, temperature setpoint is shown on the *lower display screen*. The **READY** message in the upper left corner of *upper screen* indicates that cooking oil is at temperature and the fryer is ready for cooking.



To start a cook cycle press the **[START]** key once.

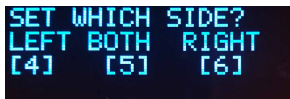

You will be prompted to select which side to start. Either or both sides can be selected as shown ... use keypad to input.

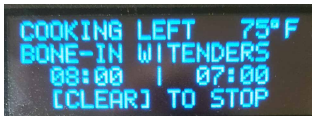

After selecting side, controller enters **COOK** state. If the fryer is equipped with automatic basket lifts, the appropriate basket(s) will be lowered into the oil and the cooking time countdown will begin in the *lower display*, while *upper display* shows which basket is cooking. The red **Timer Indicator** of the timer currently being shown will be ON.



A different *menu item* can be selected & started, or manual input can be entered for the other basket. See **Selecting a Menu Item Preset for Cooking (Section 4.1.5.2)** or **Manually Setting Cooking Time (Section 4.1.4)**.



To start the second cook cycle press the **[START]** key once again, when prompted, press the appropriate arrow key (**<4 or 6>**) to start the second timer. *Lower display* and *timer indicator* will change to show the second active timer.



When both sides are cooking, pressing the **[TIME]** key twice toggles the timer displayed on the *lower screen*. *Timer Indicator* shows which timer is currently being shown.

4.1.6 Cooking Cycle General Overview - continued

When **STIR ALARM** is active, an audible alarm sounds at a specific time in the cooking cycle to signal the operator that it is time to stir the cooking product, which helps to promote even cooking and prevent sticking. The feature must be enabled in **user settings (Section 4.1.10)** and the parameter must be set. **[STIR ALARM %]** = amount of elapsed time before the alarm sounds. e.g. if **[STIR ALARM %] = 60**, then during a *10 minute cooking cycle*, the alarm will sound after *6 minutes* of cooking time have elapsed.

Factory-set default: **[STIR ALARM ENABLE] = ON • [STIR ALARM %] = 62.**

A specific menu item **STIR OVERRIDE** setting will override the global **[STIR ALARM]** setting, see **Section 4.1.5.1.**

When the cooking cycle time is complete, an alarm will sound and the message **“DONE COOKING - (LEFT) (RIGHT) or (BOTH)”** is displayed. If fryer is equipped with basket lifts, the appropriate cook basket is automatically lifted from the oil. Pressing the **[ALARM]** key silences the alarm and the fryer re-enters **READY** state, ready to cook the next load of product.



x 2

To cancel a running cook cycle press the **[CLEAR]** key once, then press it again to cancel • **OR** • press **[<4]** to continue cooking.

4.1.7 Manually Operating Optional Basket Lifts (if Equipped)



Press the **[BASKET]** key once



Use keypad **[2] UP** & **[8] DOWN** keys to select raise or lower basket lift.

Press **[CLEAR]** to Cancel the operation.

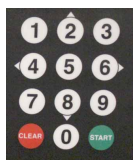

Use keypad to select basket
[4]=Left [5]=Both [6]=Right

NOTE:

- **LIFT switch on control panel must be in the [LIFT] position.**
- As a safeguard against placing product in oil that is not at the proper cooking temperature, manual operation of lifts is disabled as long as fryer is in **PREHEAT** mode.
- After a lift completes an operating cycle, it cannot be actuated again until the small red indicator above the **BASKET** key turns OFF, approximately *20 seconds*.

4.1.8 Cool Mode

COOL MODE is an energy-saving feature that lowers the oil temperature setpoint value, placing fryer into an idle standby state during periods of inactivity.



Enter **COOL MODE** by pressing the [COOL] key. The temperature setpoint changes to the **COOL TEMP** setting specified in *user settings (Section 4.1.10)*.

Factory-set default = 275°F. The setting range is **200°F - 350°F**.



+



To exit **COOL MODE** press the [CLEAR] key, then press [<4] to exit

• OR •

Press [CLEAR] again to continue **COOL Mode**.

Upon exit, the temperature setpoint returns to the previous active value and fryer enters **PREHEAT** until setpoint temperature is reached.

4.1.8.1 Auto-Cool Feature

When **AUTO-COOL** feature is turned [ON], fryer automatically enters **COOL MODE** when no cook cycles are started within the amount of time as specified by the [AUTOCOOL TIME] setting in *user settings (Section 4.1.10)*.

Factory-default: [AUTOCOOL] = OFF • [AUTOCOOL TIME] = 30. TIME setting range is **1 - 510 mins.**

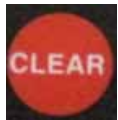

+



Exit **AUTO-COOL** same as **COOL ...** press the [CLEAR] key, then press [<4] to exit

• OR •

Press [CLEAR] again to continue **COOL Mode**.

Upon exit, the temperature setpoint returns to the previous active value and fryer enters **PREHEAT** until setpoint temperature is reached.

4.1.9 Boil Out Program



Pressing the [FUNC/BOIL] key while controller is still in **PREHEAT** mode starts the **BOIL OUT** program. Temperature and time changes to the **BOIL TEMP** and **BOIL OUT TIME** are specified in *user settings (Section 4.1.10)*. **Factory-default: BOIL TEMP = 200°F • BOIL OUT TIME = 30 minutes.** The setting ranges are **BOIL TEMP = 185° - 208°F ... BOIL OUT TIME = 1 - 45 minutes.**

IMPORTANT! Fryer must be properly drained, rinsed and prepared for cooking after the boil out process. See **Boil Out Procedure - Cleaning the Fry Vat (Section 5.2)**.

NOTE: This key will also open a menu of automatic FUNCTIONS for an Automated version of the GBF-70. To be introduced at a future date.

4.1.10 User Settings

To access the *User Settings* menu and edit settings ...

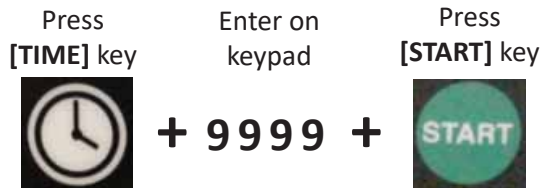

The table below details available *User Settings* and factory set *Defaults*.

Keypad [4] & [6] (left/right) will scroll through the available settings ... current setting values are shown on the *upper controller display*.



- Press the [EDIT] key, when setting is displayed to begin edit.
- Use keys [2] & [8] (up/down) to change the setting value. Press [EDIT] key again to SAVE.



To exit *User Settings* menu, press the [CLEAR] key.

NOTE:

The message “**TOO LOW**” or “**TOO HIGH**” is displayed if an entered value is outside of the allowable range and will cause a controller error.

NAME	DESCRIPTION	RANGE	DEFAULT
TEMP SCALE	Temperature unit of measure	°F or °C	°F
FORCE FILTER	If ON , forces operator to filter oil after completing the number of cook cycles specified by FILTER COUNT ... fryer will be disabled from continued use until oil is filtered.	ON - OFF	ON
FORCE FILTER SNOOZE	If ON , allows (1) additional cook cycle after FILTER COUNT is exceeded ... active only when FORCE FILTER is ON .	ON -OFF	OFF
FILTER COUNT	Number of cook cycles before filtering is required.	1 to 20	4
GUARD BAND	Cooking not allowed if oil temperature is outside of the setpoint by guard band amount.	1 to 990	900
MAX SETPOINT	Maximum oil temp setpoint allowed by controller.	32°F to 375°F	350°
AUTOCOOL	Automatically places fryer into energy-saving COOL mode after a specified amount of idle time.	ON - OFF	OFF
AUTOCOOL TIME (MINUTES)	When AUTOCOOL is ON , if no cook cycles have been started within this time, fryer automatically enters COOL mode.	1 to 510 minutes	30
AUDIBLE ALARM (SECONDS)	Duration of the audible alarm in seconds ... alarms automatically silence after this time.	5 to 120 seconds	10
COOL TEMP	Temperature setting for COOL mode	200°F to 350°F	275°F
BOIL TEMP	Temperature setting for the BOIL OUT cycle	185°F to 208°F	200°F
FILTER RESET	Temperature which resets fryer & exits FILTER MODE to unlock fryer. Applies only when FORCE FILTER is ON	200°F to 325°F	290°F
BOIL OUT TIME	Length of time (mins) for BOIL OUT cleaning cycle	1 to 45 minutes	30
STIR ALARM ENABLE	If ON , the alarm issued when a <i>specified %</i> of programmed cooking time has elapsed, alerting to stir product.	ON - OFF	ON
STIR ALARM %	If STIR ALARM ENABLE is ON , the alarm is issued after this percent [%] of cooking time has elapsed.	10% to 90%	62%
KEY BEEP ENABLE	If ON , an audible sound is generated with each keystroke.	ON - OFF	OFF

4.1.10 User Settings - continued

NAME	DESCRIPTION	RANGE	DEFAULT
LANGUAGE	Sets the controller language	English-Spanish-French	English
COOK ON MENU SELECT*	If [ON] , selecting a MENU # will automatically begin the cooking cycle. <i>Reduces the number of keystrokes needed to start a cook cycle.</i>	ON - OFF	OFF
[0] KEY EXTRA TIME	If [ON] , operator can add extra time to cook cycle (<i>after or during the cycle</i>) by pressing [0] + the number of minutes to add.	ON - OFF	OFF

* **Setting is available ONLY on dual-timer controllers.**

4.1.11 Password Protection

It is possible to add **PASSWORD** protection for certain controller settings. This feature is a **FACTORY SETTING** that is typically **DISABLED**. If **PASSCODE ENABLE** is set to **[ON]**, you are prompted to enter a password before performing many controller operations.

If you desire to have password protection enabled, or have questions concerning this feature, call **Giles Technical Services at 800.554.4537** to request the passcode and instructions as to how to enable the feature.

4.1.12 Power Up Procedure

1. Ensure that the **HEAT** switch ① is in the **[OFF]** position.
2. Place the **POWER** switch ② in the **[ON]** position. The green **POWER** light ③ will illuminate and the controller powers up and then sounds an alarm. The message "**POWER FAILURE [PRESS START TO PREHEAT]**" is shown on the *upper display screen* ④ ***This is normal*** ... to safeguard against fryer from beginning to heat while unattended, such as after power interruptions. Press the **[START]** key ⑤ to silence the alarm and place fryer into **PREHEAT** mode. The *upper display screen* shows the cook settings last used. The controller **HEAT** indicator adjacent to the *lower display screen* turns **ON**, but until the control panel **HEAT** switch ① is placed in the **[HEAT]** position, heating elements will **NOT be energized**.

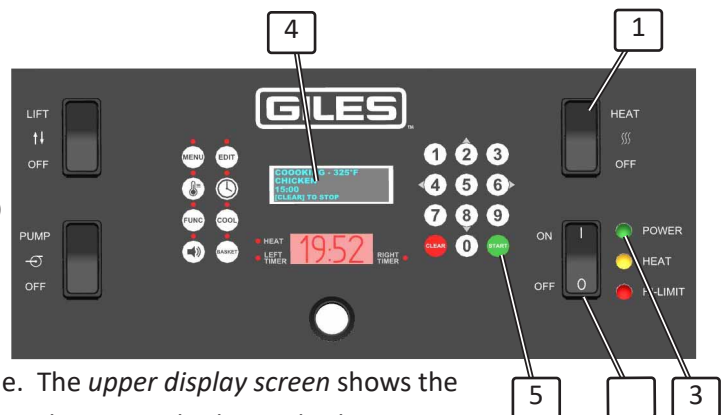

DO NOT place HEAT switch in the [HEAT] position until fry vat has been filled with cooking oil (or water). See **Section 4.2, Cooking Procedures.**

4.1.13 Controller Errors & Alarms

When conditions occur that cause unsafe operation or damage to the unit (open valves, low oil level, high temp, etc.), the controller will halt operation, activate an alarm and display error codes & messages. Error codes are shown on the *Lower display screen (red graphic)* ... error messages and prompts are shown on the *Upper display screen (blue graphic)*. Generally, heating elements are shut down until an error condition has been corrected. Pressing the **[ALARM]** key silences the alarm, but **does not** clear the error. Error codes are shown in the table below and further details are given in the following section.

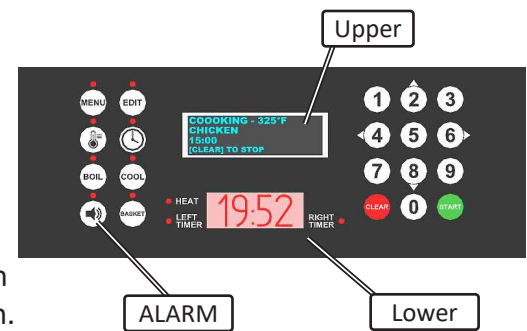

ERROR CODE	DESCRIPTION (OLED Display)	PROBLEM
OPEN	DRAIN IS OPEN	Drain valve is open, or not fully closed. Basket will be raised if it is down. Close drain to clear error.
----	CHECK OIL LEVEL, ENSURE VAT IS FULL, IF FULL THEN PRESS [START]	This is a notification error displayed after closing drain clears the OPEN error ... prompts to confirmation oil level.
ER03	LOW OIL LEVEL – ENSURE VAT IS FULL (Element/Add Level Differential Warning)	The oil level is below the ADD line in the vat. Add oil to the FULL level mark & stir. Error will remain in effect until the sensed temp differential is eliminated.
ER06	LOW OIL LEVEL – ENSURE VAT IS FULL – PRESS [START] (Post ER03 Warning)	After ER03 is cleared, this notification error is issued, prompting to confirm oil level ... fryer will heat until [START] key is pressed.
ER07	MAX ELEMENT TEMP – PRESS [START] (Post Warning)	Error is displayed as notification after MAX element temperature (ER19) has occurred and cleared ... element has cooled below temperature threshold .
ER13	OIL PROBE Error	Problem with the Variable Oil Temp sensor. Call for service.
ER15	ELEMENT PROBE Error	Problem with the Element Temp Probe, typically attached directly to heating element. Call for service.
ER17	ADD LEVEL PROBE Error	Problem with the Add Level Probe at vat ADD line. Probe cannot be bypassed. Call for service.
ER19	MAX ELEMENT TEMP Error	Maximum heating element temperature has been exceeded. Call for service ... This is a safety interlock ... NEVER bypass this probe!
ER25	GUARD BAND EXCEEDED	Actual oil temperature deviates from setpoint by the guard band value. Allow oil to cool, or heat, to within range. Factory default is 900°F ... This error should not occur.
ER37	EEPROM Error	An error occurred while saving settings to the EEPROM. Call Giles Tech Service (800.554.4537).
ER38	Internal ADC Error	The ADC (Analog-to-Digital Converter) chip that reads output from thermocouples is not working. MCB1 board must be replaced. Call Giles Tech Service (800.554.4537).

4.1.13.1 Clearing Controller Errors & Alarms

NOTE: When an error/alarm is issued and stops a cooking cycle before it is complete, it may become necessary to discard any food product that was cooking at the time ... always comply with all local Standard Operating Procedures & Best Practices.

During the following steps, instructions indicating to press the **[ALARM]** key are only to silence the audible alarm tone ... pressing the key **DOES NOT** clear the error. Tone automatically silences after about 10 secs.

- **OPEN: DRAIN OPEN** - If vat drain valve is opened (*even slightly*) while fryer power is ON, alarm sounds, *lower display screen reads OPEN, upper display screen reads "ERROR ALARM - DRAIN IS OPEN"*. Power to heating elements is shutdown and remains OFF until the error is corrected.
Press **[ALARM]** key ... clear alarm by fully closing the drain valve. After closing valve, the alarm sounds again and *upper display screen reads "CHECK OIL LEVEL, ENSURE VAT IS FULL, IF FULL THEN PRESS [START]"*. This is a post-alarm notification, alerting the operator to confirm that cooking oil is still at the **[FULL]** level. Add oil if needed, then press the **[START]** key to return to **PREHEAT** mode ... **Fryer will not heat until key is pressed.**
- **ER03: LOW OIL LEVEL** - Alarm sounds, *lower display shows Er03, upper display reads "ERROR ALARM - CHECK OIL LEVEL - ENSURE VAT IS FULL"*. Heating elements are shutdown until the condition is corrected. The detected differential between a temperature probe at the **[ADD]** level and one attached to a heating element exceeds an acceptable amount, indicating **low oil level, which greatly increases the potential for a vat fire!** Press the **[ALARM]** key ... allow fryer to cool adequately in order to reset fryer error condition. Add oil to raise level to the **[FULL]** mark, as needed.
- **ER06: LOW OIL LEVEL Post-error Warning** - After **Er03** has been cleared, another alarm sounds. The *lower display shows Er06, upper display reads "CHECK OIL LEVEL - ENSURE VAT IS FULL - PRESS [START]"*. This alarm alerts operator to confirm that cooking oil is at the **[FULL]** level. If situation has been corrected, press **[START]** key to enter **PREHEAT** and proceed to continue cooking operations ... **Fryer will not heat until key is pressed.**
- **ER19: MAX. ELEMENT TEMP** - Temperature of heating element has exceeded the **maximum allowed** by the controller. Alarm sounds, *lower screen shows Er19, upper screen reads "ERROR ALARM - MAX ELEMENT TEMPERATURE"*. Power to heating elements is shutdown. Press **[ALARM]** key ... elements must cool below the allowable temperature threshold to clear this error. Typical cause is that the heating element has been exposed due to low oil level (or no oil). False alarms can occur when preheating **cold oil** at beginning of the day ... regular stirring of oil while preheating will help avoid such false alarms.
- **ER07: MAX ELEMENT TEMP Post-Error Warning** - After an **Er19** error has been cleared, a secondary notification alarm occurs. The *lower screen reads Er07, upper display reads "MAX ELEMENT TEMP - PRESS [START]"*. The alarm notifies operator that a **maximum element temperature error** has occurred and is now cleared. Press **[START]** key to enter **PREHEAT** mode ... **Fryer will not heat until key is pressed.**

NOTE: If an error condition persists and cannot be resolved, it could be an indication of component failure or system malfunction. Please contact a factory-authorized service agent, or call 800.554.4537 for Giles Technical Support.

4.2 Cooking Procedures

This section explains procedures for cooking with the **GBF-70** electric fryer and assumes you are beginning with a properly installed, clean, empty fryer. *Owner/operator work practices and procedures must also be followed and may supersede the processes presented in this manual.*



1. Ensure that **HEAT** switch ③ is in the **[OFF]** position and remains so at this time.
2. Place the **POWER** switch ① in the **[ON]** position, **POWER** light ② turns ON. Controller powers up as described in **Section 4.1.12**. When the alarm sounds, press **[ALARM]** key ⑤ to silence ... **DO NOT** press **[START]** as prompted by the controller.
3. While the **"POWER FAILURE"** message is displayed on upper display screen, set the desired cooking oil temperature as described in **Section 4.1.3, Setting the Cooking Temperature**.
4. Confirm that the **drain valve handle** ⑧ inside the cabinet is in the **[CLOSE]** position (full left to a stop). **IMPORTANT! Fryer will not heat unless drain valve is fully closed.**
5. Add your preferred liquid frying shortening to vat ... fill to the **[ADD]** mark **ONLY** to allow for expansion as oil is heated to the set temperature.

◇ **Using an Optional Bulk Fresh Oil Supply System:** If fryer is connected to a *bulk fresh oil supply system*, follow the steps below: **NOTE: The optional on-board Top-Off system is not meant for filling vat with a volume of oil required for cooking.**

- Position the **OIL RETURN** valve handle ⑨ into the **[FILL POT]** position. **On a banked system, only the valve of the well being filled should be set in this position ... all others must be in [CLOSE] position.**
- The **OIL FILL** pushbutton switch ⑥ on control panel is directly connected to the bulk oil system pump.
- Press and hold pushbutton to activate the system pump. While holding the switch, observe vat filling from the bulk system. **Switch must be held ... pump stops if pushbutton is released.**
- Release switch to stop flow when oil level reaches **[ADD]** mark.
- Return the **OIL RETURN** valve to the **[CLOSE]** position.

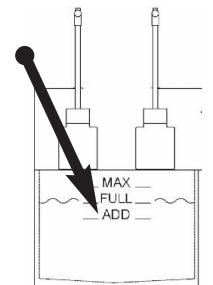
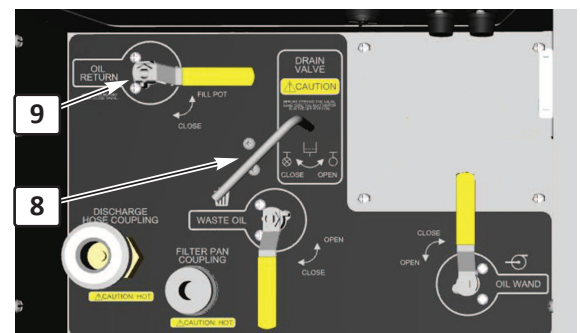

4.2 Cooking Procedures - continued

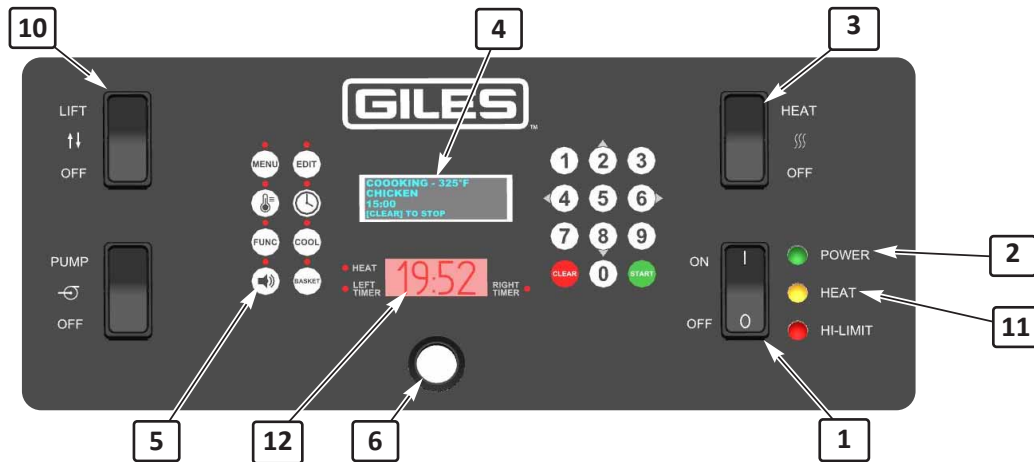

6. If unit is equipped with optional basket lifts and you wish to use them, place the **LIFT** switch (10) in the [LIFT] position. *There is no lift switch on the control panel if basket lifts are not installed.*
7. At this time, place **HEAT** switch (3) in the [HEAT] position ... amber **HEAT** light (11) on control panel will illuminate. Heating elements are energized and oil begins heating to the setpoint temp entered in **Step #3**. The *upper display* (4) shows that fryer is in **PREHEAT** mode and the *lower display screen* (12) shows the current real-time oil temperature.

CAUTION Cooking oil in fryer will become extremely HOT! Always wear thermal protection, such as oven mitts or gloves, when stirring oil.

8. While fryer is preheating, you should stir oil occasionally to promote even heating and to prevent possible occurrence of false **HI-LIMIT** alarms. False alarms are more likely during the initial heating of the day, when shortening may be cool and somewhat thickened.
9. When cooking oil reaches the set temperature, an alarm sounds and the message "**ALARM - STIR OIL**" appears on the *upper display screen* (4). Press the [ALARM] key (5) ... vigorously stir oil with the provided stirring utensil. Oil temp generally decreases when stirred ... controller delays *10 seconds* and if actual temp drops below setpoint while stirring, fryer will remain in **PREHEAT** until setpoint is reached again. A second alarm sounds and the message "**ALARM - SETPOINT REACHED**" is displayed. Press the [ALARM] key ... fryer enters **READY** state and temperature displayed on the *lower display screen* (12) changes to show setpoint temperature.

Oil should now be evenly heated and ready for cooking.

10. Check oil level, it should now be at the [FULL] level mark. Add shortening if needed and stir. If the **HEAT** light turns ON while adding more oil, wait until it turns OFF again before cooking.

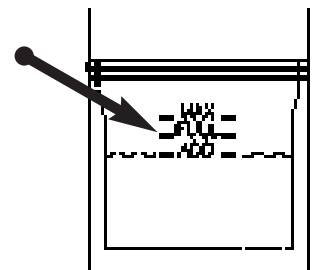

4.2 Cooking Procedures - continued

- Place the **basket support/crumb screen** (13) into the vat with handles to the side.
- If optional **Basket Lifts** are installed, raise both to the UP position as described in **Section 4.1.7, Manually Operating the Basket Lifts**. Hang **baskets** (14) onto **basket carrier arms** (15).

If lifts are not installed, hang baskets onto the **basket hanger rack** (16) on the back cabinet header.

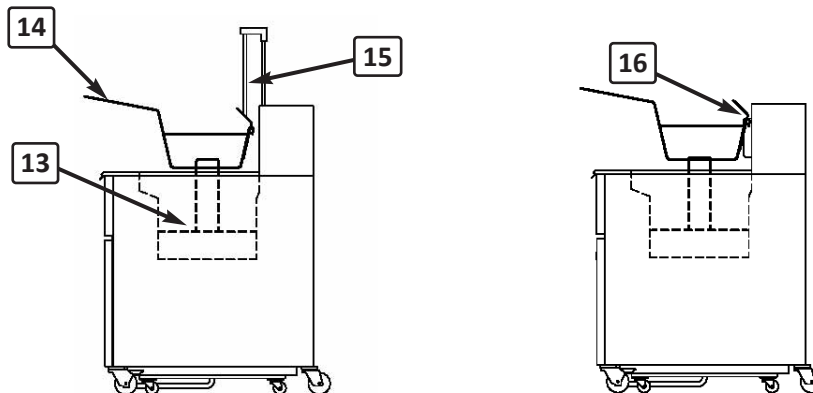

NOTE: Fryer w/Basket Lift Option:

If you desire not to use basket lifts, leave them in the UP position, place the **LIFT** switch in **[OFF]** and use the raised carrier arms as a basket hanger rack.

WARNING

During cooking operations, oil level **MUST** be maintained between **[FULL]** & **[ADD]** level marks. If level falls below **[ADD]**, controller issues an alarm and the heating elements will be shutdown & remain **OFF** until error is cleared. Unit may be equipped with an *optional Oil Top-Off* feature which will allow you to quickly and easily maintain oil level, refer to **Section 4.3**.

- The recommended **“best practice”** for loading uncooked food items into the fryer is to first place product into the **basket**, then place it into hot oil. This can help avoid possible burn hazards when handling food near hot oil ... oil splash, splatter and lack of operator attention can result in skin contact with the extremely hot oil.

When fryer is equipped with *optional* basket lifts, the basket will be lowered automatically into oil when the cooking cycle is started.

Product may also be loaded into a basket after it has already been placed into the oil. If using this method, always wear appropriate personal protection (thermal mitts or gloves) to avoid possible burn injury.

CAUTION

Use extreme caution when dropping food product into **HOT** cooking oil! Serious burn injuries can occur if hot oil contacts unprotected skin, such as could be caused by an unexpected splash. Loading items containing excessive moisture or loading larger than recommended quantities can cause surge boil and result in overflow of **HOT** oil. Use caution when loading foods and observe how the hot oil reacts before continuing.

4.2 Cooking Procedures - continued

A. Fryer WITH Optional Basket Lifts:

- With basket hanging on a raised **basket carrier arm**, load fresh uncooked product into it.
- Select the appropriate *Menu Item Preset* (see **Section 4.1.5.2**), or manually enter a desired cooking time (see **Section 4.1.4**).
The same or different settings can be assigned to each basket. The active cook settings and status appear on the *upper display* for each basket. **NOTE:** If the user setting **"COOK ON MENU SELECT"** is set [ON] & fryer is **READY**, basket lowers & cook cycle will begin as soon as side is selected without needing to complete **step #16** ... otherwise proceed to next step.
- With **READY** status shown, the fryer is ready to cook. Press [START] key then use keypad to select which basket to begin cooking ... [4] LEFT • [5] BOTH • [6] RIGHT. The appropriate basket is lowered automatically into oil and the programmed cooking time countdown appears on the *lower display screen*.

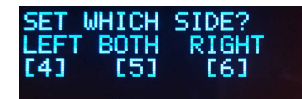
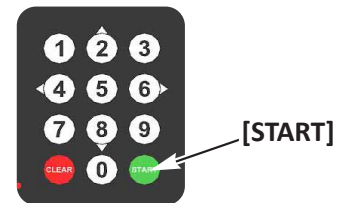

If [BOTH] is not selected, the other side can be started in like manner.

B. Fryer WITHOUT Basket Lift Option:

- Hang empty baskets on the manual **basket hanger rack** on the cabinet header. Load fresh, uncooked product into basket.
- Either select the appropriate *Menu Item Preset* (see **Section 4.1.5.2**), or manually enter a desired cooking time (see **Section 4.1.4**).
The same or different settings can be assigned to each basket. The active cook settings and status appear on the *upper display* for each basket. **NOTE:** If the user setting **"COOK ON MENU SELECT"** is set [ON] & fryer is **READY**, basket lowers & cook cycle will begin as soon as side is selected without needing to complete **step #16** ... otherwise proceed to next step.
- With **READY** status shown, the fryer is ready to cook. Press [START] key then use keypad to select which basket to begin cooking ... [4] LEFT • [5] BOTH • [6] RIGHT. Immediately remove the appropriate basket(s) from hanger rack and place into the vat, sitting on the *basket support screen* in bottom of vat. The programmed cooking time countdown appears on the *lower display screen*.
If [BOTH] is not selected, the other side can be started in like manner.
- Upper display* shows which side is **COOKING ... LEFT • RIGHT • BOTH**.
Lower display shows the countdown of remaining cook time.

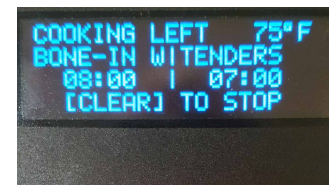

When both sides are cooking, pressing the [TIME] key twice (x2) toggles between the active timers. **Timer Indicator** shows which is currently being shown.

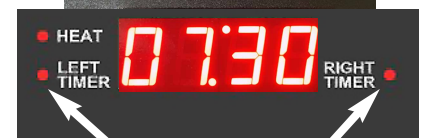

CAUTION Always wear thermal personal protection, such as gloves or oven mitts, when handling hot baskets or while stirring oil in the vat.

4.2 Cooking Procedures - continued

STIR ALARM NOTE:

Step #18 applies only if user setting “STIR ALARM ENABLE” = [ON] and menu item setting “STIR OVERRIDE” = [NORMAL] for the menu item being cooked.

•• OR ••

“STIR ALARM ENABLE” = [OFF] and “STIR OVERRIDE” = [FORCE] for the item.

If these settings are not in active, STIR ALARM is *not issued*.

As a “best practice”, it is recommended that the cooking product be stirred during the latter half of the cook cycle to help promote even cooking and to prevent pieces from sticking together.

18. When active, **STIR ALARM** sounds after a preset amount of the programmed cook time has elapsed. The message “**ALARM - STIR (LEFT) or (RIGHT) or (BOTH) SIDE**” appears in the upper display screen (18). Press the [ALARM] key (19) ... use the provided utensil (17) to stir the product cooking in the basket. If basket lift is used, be sure that the basket remains hooked to the basket carrier arm.

19. **WITH Optional Basket Lifts:** When programmed cook time has expired, an alarm sounds and the message “**ALARM - DONE COOKING (LEFT) or (RIGHT) or (BOTH)**” appears on the upper display screen. Basket is lifted automatically from the oil. Press [ALARM] key (19) to silence alarm.

WITHOUT Optional Basket Lifts (not installed or disabled): Same as above except basket is manually removed from oil and placed onto hanger rack (or raised basket carrier arm). Press the [ALARM] key (19) to silence alarm.

20. In accordance with your specific standard operating procedures or prevailing health regulations, the internal temperature of cooked protein product should be checked for doneness after cooking cycle is completed. Check using an instant-read probe-style food thermometer.

If additional cooking time is required, there is a user setting in the **GBF-70** controller that will allow operators to quickly and easily add any amount of needed additional time (either during the cycle or after it is complete). Refer to **User Setting “[0] KEY EXTRA TIME”** in Section 4.1.10.

21. After doneness is verified, allow cooked product to adequately drain, then dump into an appropriate dump station, or food service pan. Always comply with health regulations pertaining to holding foods prior to sale.

22. The fryer should be ready for continued cooking. Return to **Step #13**.

To shut-down unit, see **Section 4.5, Normal Shut-Down**.

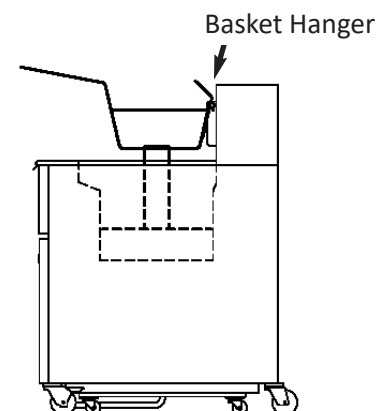
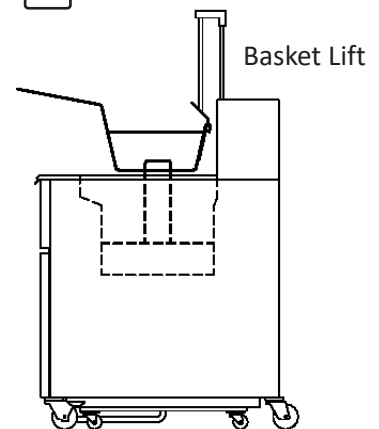
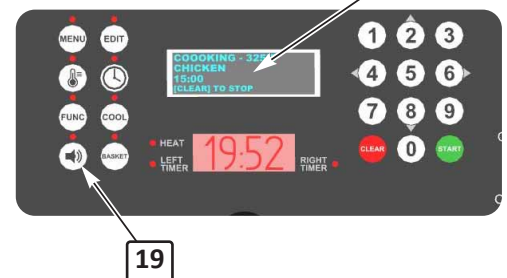
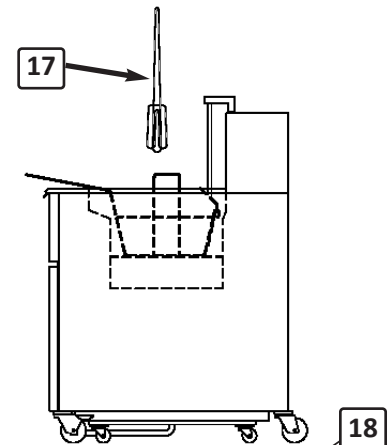

4.3 Optional Oil Level Top-Off Function

The optional **Oil Level Top-Off** feature makes maintaining oil level in vats virtually *hands-free*. Fresh oil is supplied from either an **on-board supply** or a “**customer-provided**” **bulk oil management system**.

On-board system ... two configurations: A single fryer utilizes a removable **saddle-bag style tank** that hangs on the fryer side with the supply of oil being manually maintained by operators. Banked units utilize a **jug-in-box (JIB)** design that pumps fresh oil directly from a purchased jug of oil. An on-board top-off pump is controlled by a single pushbutton switch on the fryer control panel.

Bulk oil system ... Fryer is factory-configured for connection to a customer-provided **bulk oil system** ... that system’s internal pump is wired directly to the **OIL FILL** pushbutton switch on control panel ②.

As “**best practice**” and to avoid possible loss of product, you should continually monitor vat oil levels to prevent controller from issuing a “**LOW OIL LEVEL**” alarm while cooking, which will result in shutdown of power to heating elements. Top-off oil should always be added when there is NO product in the vat. **DO NOT** use the “**LOW OIL LEVEL**” error as a signal to top-off vat ... routinely monitor oil levels visually.



JUG-IN-BOX



SADDLE TANK

Adding Top-Off Oil to Vat:

- Open cabinet (*unit to top-off on banked systems*) and position the **OIL RETURN** valve handle ① in the **FILL POT** position. On *banked systems*, all other valves must be in the [CLOSE] position.
- On control panel, press and hold the **ADD OIL** push-button switch ② to start the *on-board top-off pump* or *bulk system pump* ... fresh oil is pumped to vat from the appropriate supply location.

NOTE:

Pump ONLY runs while pushbutton is being pressed ... releasing the switch will stop the oil flow.

- Hold button and observe filling. When the observed oil level reaches the [FULL] level mark, release pushbutton to stop oil flow.
- Return the **OIL RETURN** valve handle to the [CLOSE] position.
- If an alarm had been issued, it should clear when oil level is corrected, refer to **Section 4.1.13.1**.

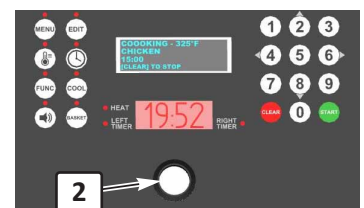
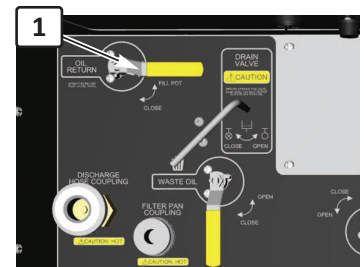

4.4 Filtering Used Cooking Oil Using On-Board System

This section explains filtering and reconditioning of used cooking oil using the *on-board oil filtration system*. The process involves draining used oil into *filter pan*, which contains the filter media. A filter aid/conditioner compound is added, then the system pumps the used oil through the filter media and recirculates it back to the vat. The oil circulates for several minutes to filter out debris and recondition it by removing certain soluble impurities. **Performing the process as prescribed can effectively increase the useful oil life by as much as 50%.**

As a best practice, it is recommended that cooking oil be filtered at least after every fourth (4th) load cooked (**both baskets dropped at the same time**).

Controller has a programmable **FORCE FILTER** feature, that can be set to force operating personnel to perform an oil filtration process after a set number of cooking cycles have been completed. The feature is configured in **User Settings, Section 4.1.10:**

- **FORCE FILTER - [ON] or [OFF] ... Factory default is [ON].**
 - [ON] = After completing the number of cook cycles specified by **FILTER COUNT**, the alarm sounds and the message **"ALARM - MUST FILTER OIL"** appears on the *upper display screen*. Pressing the **[ALARM]** key silences alarm and the controller enters **FILTER MODE**. The fryer will be **locked out** of continued operation until cooking oil is properly filtered.
 - [OFF] = After completing the number of cook cycles specified by **FILTER COUNT**, the alarm sounds and the message **"ALARM - FILTER OIL"** appears on the *upper display screen* ... this serves ONLY as an alert notification. Pressing the **[ALARM]** key silences alarm and returns fryer to **READY** state. You can continue cooking operations, however this alarm and notification will continue to appear after every subsequent cook cycle until cooking oil is properly filtered.
- **FILTER COUNT - 1 to 20 ... Factory default is 4.**

The number of cook cycles which may be performed before controller enters **FILTER MODE**. *Controller counts a cook cycle run as (1), regardless of whether one or both baskets are used.*
- **FORCE FILTER SNOOZE - [ON] or [OFF] ... Factory default is [OFF].**

Effective only when **FORCE FILTER** is **[ON]**

 - [ON] = Allows operator to cook **one (1) additional load of product** after **FILTER COUNT** is exceeded, before fryer enters **FILTER MODE** and is *locked out* of further operation.
 - [OFF] = Additional cook cycle is not allowed.

Additionally, each *Menu Item Preset* has an available **FISH FILTER** setting ... when set to **[ON]** this setting overrides the global **FORCE FILTER** setting and puts fryer into **FILTER MODE** after only (1) *batch* of the particular menu item is cooked. Setting is typically used for seafood products to help minimize possibility of flavor transfer. See **Section 4.1.5.1** for more detail.

CAUTION

Never attempt to perform filter process when cooking oil is cold ... thick cold oil can possibly clog and damage the filter system. Oil should be at a temperature of at least 200°F [93°C] before attempting to filter.

To avoid possible burn injury, always wear thermal personnel protection (gloves or mitts), while performing the filter process. Fryer parts inside the cabinet become extremely HOT!

4.4 Filtering Used Cooking Oil Using On-Board System - continued

A. Preparing Fryer for Filter Process



1. If necessary, press [ALARM] key ① to silence an alarm. Ensure that **POWER** switch ② is [ON] ... power for the unit being filtered **must** remain [ON] throughout the process to keep controller powered.
2. Place the **HEAT** switch ③ of the unit being filtered in the [OFF] position. As added precaution against accidental oil fire, the switch **must** remain [OFF] throughout the process.

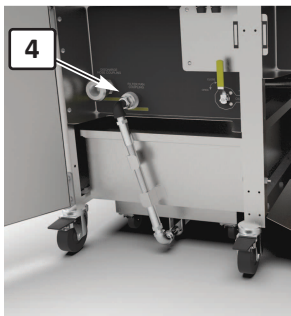

3. Open cabinet door (*unit w/filter pan on banked units*). Disconnect the **filter pan hose** ④ (push in slip-ring, and pull hose from connector). Pull **filter pan** from unit. Remove **filter pan cover** and the lift-out **crumb screen** ... dispose of any collected crumbs and residue.
4. Inspect to ensure that filter media (typically paper) is in place and that the majority of residue from any previous filter cycle has been cleaned from the surface. Ensure that the **hold-down frame** is properly locked in place.

5. Evenly distribute approximately **5 ozs.** of a suitable filter aid over the filter media surface. Use of a good quality filter aid compound is essential for removing soluble impurities and reconditioning the oil. **Portion packed Filter Powder is available through Giles' distributors and equipment dealers ... P/N 72004.**



6. Replace the **crumb screen** and **pan cover**, then reposition assembled filter pan under the fryer and reconnect hose ④ (push in white slip-ring while inserting brass fitting into coupling). Filter hose **must** fit tightly and securely.
7. Confirm that **HEAT** switch remains in the [OFF] position and the **POWER** switch remains in the [ON] position (**switch must be [ON] throughout the filter process**).
8. **On the unit being filtered**, remove **baskets** and the **support/crumb screen** from the vat.

⚠ DANGER During the following phase, cooking oil is drained from the vat, exposing the heating elements. Though safety interlocks are active, failure to keep the HEAT switch in the [OFF] position while draining could increase the risk of an oil fire. **ALWAYS BE SURE THAT THE HEAT SWITCH REMAINS IN THE [OFF] POSITION DURING THE FILTERING PROCESS.**

⚠ WARNING • **For Banked Units: DO NOT** drain more than one (1) vat at a time into the filter pan! It **ONLY** has the capacity to hold the oil of one (1) cook vat.

- Never disconnect and attempt to remove the filter pan from unit while it contains cooking oil.

4.4 Filtering Used Cooking Oil Using On-Board System - continued

B. Filtering Process

9. Complete the filtering procedure as follows.

- In the lower cabinet of the unit being filtered, place the **OIL RETURN** valve handle (6) to the **[FILL POT]** position
- Ensure the **OIL WAND** handle (5) and **WASTE OIL** handle (7) (if equipped) are in the **[CLOSE]** position (*on banked units, these valves are only located in the main unit that contains the filter pan*).

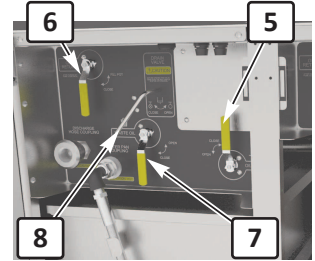

- **On the unit being filtered** ... Slowly move the **DRAIN** valve handle (8) to the **[OPEN]** position (fully right to a stop). Oil should begin draining from vat. *If oil does not readily drain, use the provided round-bristle Drain Brush to break up residue that might be blocking the vat drain.*
- After the majority of used oil has drained into the *filter pan*, place **PUMP** switch (9) on control panel in the **[PUMP]** position (*on banked systems, switch is only located on the unit with filter pan*).



- Filter pump will start, drawing oil through the filter media and pumping it back into the cook vat. Leave the drain valve open and allow oil to continually recirculate as a “*crumb wash*” to flush crumbs and residue from vat into the *filter pan*. During this time use the provided soft-bristle, heat-resistant *pot brush* and round-bristle *element brush* to clean residue from vat sides and heating elements, allowing it to be flushed out of the vat.
- After approximately **5 minutes**, slowly return the **DRAIN** valve handle (8) to the **[CLOSE]** position (fully left to a stop) and allow the vat to refill with filtered/reconditioned cooking oil.
- When vat has filled and no more oil is being discharged from the oil return fitting, return **PUMP** switch (9) to the **[OFF]** position, and then return the **OIL RETURN** valve (6) to the **[CLOSE]** position.
- Visually confirm that oil level is satisfactory ... between the **[ADD]** & **[FULL]** level marks. Add fresh oil as needed. If **Top-Off option** is installed, refer to **Section 4.3, Oil Top-Off**.
- **FILTER MODE** should now be reset ... press the **[CLEAR]** key to return fryer to **PREHEAT** mode and place the **HEAT** switch (3) in the **[HEAT]** position to begin reheating oil to set cooking temperature.

C. Filter Process - Complete & Prepare for Cooking

CAUTION Always wear thermal protection when performing this step. Parts can be excessively hot!

10. After refilling vat, remove **filter pan** from fryer (see Step #3) and remove **pan cover**. Remove the **crumb screen** and empty as needed. Taking care not damage the filter media, use the provided **crumb shovel** and scoop filter sediment from the media surface and dispose of properly. It is not essential that filter media be refreshed after each filter cycle. As a “**best practice**”, the **filter pan** should be thoroughly cleaned and filter media replaced on a **daily basis** (refer to **Section 5.3**).

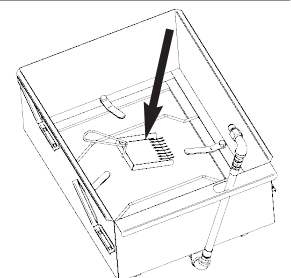

4.4 Filtering Used Cooking Oil Using On-Board System - continued

11. Reassemble and install **filter pan** under fryer and reconnect hose to the fryer coupling.

12. To continue cooking, see **Section 4.2, Cooking Procedure**.

To discontinue cooking, see **Section 4.5, Normal Shut-Down**.

4.5 Normal Fryer Shutdown

Fryer shutdown applies to each unit of a **banked system**.

1. Place **HEAT** switch ① in the **[OFF]** position.
2. Place **POWER** switch ② in the **[OFF]** position.
3. If standard practice requires, shutdown supply power to the fryer at the main electrical panel to completely remove all power.



4.6 Emergency Shutdown

In case of emergency, disconnect supply power from the unit by switching off circuit breakers or disconnects in the building's main electrical panel(s).



Notes:

5. Cleaning & Maintenance

This section explains cleaning and maintaining procedures for the **GBF-70** fryer that are necessary to keep it in good operating condition.

⚠ DANGER **DO NOT** wash down fryer interior or exterior with water from a spray hose. Control panels are “liquid-resistant”, but are **NOT** washdown safe.

Failure to comply with **DANGER** notices will result in serious injury, even death, damage to equipment or property damage, and could void the factory warranty.

5.1 Removing & Disposing of Waste Cooking Oil

This section explains the procedure for removing and disposing of waste cooking oil from fryer. To maintain food quality, oil should typically be changed every **7 to 10 days**, depending on filtering practices, types and quantities of foods regularly in the fryer. Test kits are available from most restaurant supply distributors, which can determine oil condition to assess if it needs to be replaced. Oil must also be removed before performing a fryer boil-out.

GBF-70 fryers are optionally capable of being connected to a customer provided **Bulk Oil Management System** for bulk handling of waste oil. Please note that procedures will differ based on your equipment’s particular configuration.



⚠ CAUTION **DO NOT** attempt to pump cold oil. Doing so can possibly clog the filter system and damage the unit. Oil should be heated to at least 200°F (93°C) before pumping.

1. If oil is cold, heat to at least **200°F (93°C)**.
2. On the unit being drained, place the **HEAT** switch ② in the [OFF] position.
3. Ensure that the **filter pan** ③, along with **filter pan cover**, is properly positioned. Confirm that the **filter pan hose** ④ is connected properly and securely at the quick-coupling fitting. On banked systems, filter pan is located inside the left-hand unit cabinet.

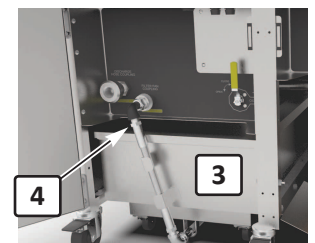

⚠ DANGER During the following phase, cooking oil is drained from the vat, exposing the heating elements. Though safety interlocks are in place, failure to have the *Heat Switch* in the [OFF] position before draining could increase the risk of oil fire. **ALWAYS BE SURE THAT THE HEAT SWITCH REMAINS IN THE [OFF] POSITION THROUGHOUT THE PROCESS.**

⚠ WARNING • **On banked systems, DO NOT** drain more than one (1) vat at a time into the *filter pan*! Pan has capacity to hold the oil from ONLY one (1) cook vat.

- Never disconnect and attempt to remove the filter pan from unit while it contains cooking oil.

5.1 Removing & Disposing of Waste Cooking Oil - continued

4. Drain oil from vat; **ensure that HEAT switch remains [OFF]:**

- **On the unit being drained** ... slowly move the **drain valve handle** ⑦ to the [OPEN] position (fully right to stop). Oil should begin draining from vat. **If the vat does not readily drain, use the provided round-bristle Drain Brush to break up residue that might be blocking the drain.**

◇ After about one-third of the oil drains from vat, use the provided heat-resistant **pot brush** to rake crumbs and residue into the drain ... **allow oil to completely drain from the vat.**

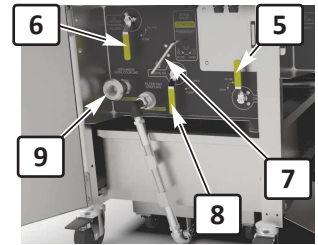

IMPORTANT!!

To avoid pump damage, should pressure build up excessively while pumping waste oil, a pressure sensor switch will shutdown the pump until any high pressure is relieved.

5. Discharging waste oil from fryer:

• **Fryer Connected to a Bulk Oil System -**

◇ Ensure the **OIL WAND** valve handle ⑤ is in the [CLOSE] position (*on banked system, valve is located inside the left-hand cabinet with the filter pan*). Ensure **OIL RETURN** valve(s) ⑥ is in the [CLOSE] position ... **valve in all units in a banked system must be closed to prevent waste oil from returning to the vat.**

◇ After all oil drains from vat, place the **WASTE OIL** valve ⑧ in the [OPEN] position.

◇ Start pump by placing **PUMP** switch ⑪ in [PUMP] position (*on banked systems, switch is located on left-hand unit control panel*). Waste oil is pumped from the **filter pan** out to the connected **bulk waste oil collection tank**.

◇ When pan is emptied, the sound of the pump should noticeably change ... return **PUMP** switch to [OFF].

DO NOT allow pump to run for an extended amount of time without oil pumping.

◇ Return **WASTE OIL** valve ⑧ to [OFF] position.

• **Discharge Waste Oil to Portable Container with Hose -**

◇ Connect the provided **waste oil discharge hose** to the **discharge hose coupling** ⑨ inside cabinet (*on banked systems, coupling located inside unit with filter pan*). Push in on white slip-ring while inserting male hose fitting and ensure the connection is secure.

◇ Place the **discharge wand** end of hose into an appropriate waste oil disposal container ⑩ (*not provided*).

◇ Ensure the **WASTE OIL** valve ⑧ is positioned to [CLOSE].

◇ Place the **OIL WAND** valve ⑤ in [OPEN] position.

◇ Start pump by placing **PUMP** switch ⑪ in [PUMP] position (*on banked systems, switch is located on left-hand unit control panel*). Waste oil is pumped from the **filter pan** through the **discharge hose** to a portable disposal container.

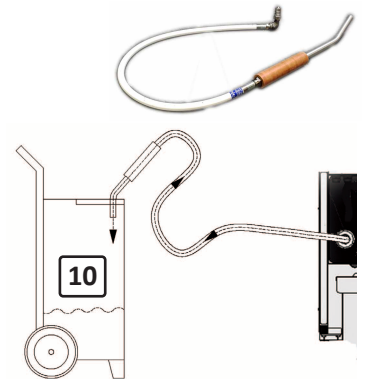

CAUTION

When holding the hose while pumping, wear thermal protection (gloves or oven mitts). Even with the insulating handle, some parts of the hose assembly can become very hot!

5.1 Removing & Disposing of Waste Cooking Oil - continued

- ◇ When pan is emptied, oil flow from discharge hose will stop ... return **PUMP** switch to **[OFF]**.
DO NOT allow pump to run for an extended amount of time without oil pumping.
 - ◇ Return **OIL WAND** valve (8) to **[CLOSE]** position.
 - ◇ Remove the **discharge hose** from fryer coupling and drain any oil remaining in it into the disposal container.
6. Allow the *filter pan* to cool sufficiently and remove. Disassemble and clean thoroughly. See **Section 5.3**.
 7. After removing waste oil, a **boil-out procedure** should be performed in a timely manner to clean & degrease the vat. See **Section 5.2, Boil-Out Procedure**. **DO NOT** allow oil residue to remain in the vat for an extended period of time. Doing so will make it difficult to clean and can eventually cause undesirable build-up, which can negatively impact fryer performance and food quality.
 - ◇ At a minimum, if **boil-out** must be delayed, use absorbent paper wipes to clean as much of the waste oil residue as possible from the vat and heating elements and then immediately refill the vat with fresh oil, see **Section 4.2, Cooking Procedures, step #4**.
 8. Clean the *filter pan* as described in **Section 4.4, step #10**, replace in fryer and connect hose.

5.2 Boil-Out Procedure - Cleaning the Fry Vat

The following explains using the **Boil-Out** process to clean the cook vat. This procedure must be performed before cooking on new equipment and should be performed immediately following each time waste cooking oil is removed from the fryer, before refilling it with fresh oil.

For proper maintenance and to ensure satisfactory operation and food quality, the process should be performed, at a minimum, every 7 to 10 days.

CAUTION **DO NOT** leave the fryer unattended during this process. While it should not occur, preventive action may be needed to prevent a rolling boil and vat overflow. A rolling boil is **NOT** required for proper cleaning action.

1. Remove used cooking oil from the unit as described in **Section 5.1, Removing & Disposing of Waste Cooking Oil**.
2. Confirm that the *drain valve handle* on the unit to be cleaned is turned fully to **[CLOSE]** position.
3. Ensure **HEAT** switch on unit to be cleaned is in the **[OFF]** position.
4. Use absorbent paper wipes to clean as much waste oil residue as possible from the vat and heating elements. Fill vat to the **[FULL]** level mark (1) with clean water.
5. Use a reputable **fryer cleaning & degreasing** product and follow the manufacturer's directions for use. Add recommended amount of product to the water and stir gently to mix.

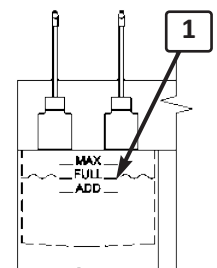

Fryer Boil Out cleaner is available through **GILES' distributors and equipment dealers** ... item #72003-1, 8-lb Jar or #72003, case of 4 Jars.

CAUTION Closely follow the cleaning product manufacturer's use instructions and hazard warnings. Some available cleaners may contain caustic chemicals and require special precautions when used to avoid personal injury and/or damage to the fryer.

5.2 Boil-Out Procedure - Cleaning the Fry Vat - continued

6. **On the unit being cleaned** ... Place the **HEAT** switch ① in **[ON]** position ... unit should enter **PREHEAT** mode.
7. Press the **[FUNC/BOIL]** key ②.
8. Controller will enter **BOIL OUT MODE** ... temperature setpoint automatically changes to **200°F** and boil-out time begins counting down from **30 minutes** (displayed on the *lower display screen*) ... boil-out solution begins to heat.



- Default **Boil Out Temperature** and **Time** are factory-set at **200°F & 30 mins**. If a different temperature or time is required, settings can be changed in **User Settings, Section 4.1.10** ... **[BOIL TEMP]** range is **185° - 208°F**. **[BOIL OUT TIME]** range is **1 - 45 minutes**.
 - If necessary, the boil-out process can be stopped by pressing the **[CLEAR]** key ④ ... a confirmation prompt is displayed on the *upper display*. Press keypad **<4>** to stop or press **[CLEAR]** again to continue the process.
9. At the completion of the boil-out time, the alarm sounds and the *upper display* shows message **"ALARM - COOKING DONE"**. Press the **[ALARM]** key ⑤ to silence alarm and exit **BOIL OUT MODE**
NOTE: As a safety measure, the controller automatically resets the temp setpoint to 50°F when boil out mode is concluded. Setpoint must be reset to a cooking temp after refilling vat with fresh oil.

10. Place the **HEAT** switch ① in **[OFF]** position.
11. Disconnect **filter pan hose** ⑥ and remove the **filter pan** from the unit. **On banked systems, filter pan is located inside the left-hand unit cabinet.**

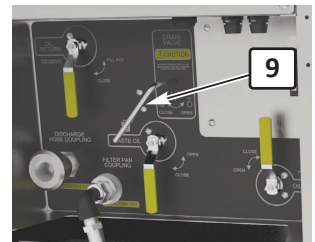

CAUTION **NEVER** drain spent boil-out solution into the **filter pan** or run it through the filter system using the pump. Some fryer cleaning products may be caustic and will damage the pump and/or other system components. Doing this will void the factory warranty!

12. Place a suitable **heat-resistant container** ⑧ beneath the fryer drain in place of the filter pan.

**Giles offers a boil out caddy (BOC) designed for this process which can be purchased separately. Otherwise, container used for this step must be heat resistant up to 300°F (148°C). Common plastic containers are not acceptable ... they can melt or break. A leak-proof metal container is ideal. Failure to comply with this caution may result in personal injury.*



NOTE: Banked fryer systems have multiple drain tubes. Be certain container is positioned so that it will properly capture the used boil-out solution when drained.

13. **On the unit being cleaned**, slowly turn the **drain valve handle** ⑨ to the **[OPEN]** position (to right fully to a stop) ... completely drain used boil-out solution into the catch container.
14. As needed, use the provided heat-resistant brushes to scrub vat sides, bottom, and heating elements to remove loosened residue. Rinse and flush the vat thoroughly with warm clean water. **Take care not to damage temperature probes protruding through the front vat wall.**

IMPORTANT!!

- **Closely monitor the catch container. Close drain valve and empty container as often as needed to avoid overflow while draining and rinsing.**
- **If a floor drain is located near the fryer it should be acceptable to slowly drain solution onto floor and squeegee it into the drain (a helper will be needed to assist with this option).**

15. After draining and thoroughly rinsing vat, return drain valve to the **[CLOSE]** position.

5.2 Boil-Out Procedure - Cleaning the Fry Vat - continued

16. Use sanitized absorbent towels, or clean paper wipes, to completely dry the cook vat and heating elements. Properly dispose of the used boil-out solution.
17. Confirm that the drain valve has been returned to the [CLOSE] position.
18. Clean the *filter pan* and replace filter media as described in **Section 5.3, Cleaning the Filter Pan & Refreshing Filter Media**.
19. Reposition *filter pan* in fryer cabinet (**left-hand unit on banked systems**) and reconnect hose at the *filter pan coupling*. The connection must be tight and secure to ensure proper pump performance.
20. Refill fryer with fresh cooking oil as described in **Section 4.2, Cooking Procedures** and prepare to resume cooking activities. **NOTE: The cooking temperature setpoint in the controller must be reset before oil will heat after refilling vat.**

5.3 Cleaning the Filter Pan & Refreshing Filter Media

The following procedure describes cleaning *filter pan* and refreshing *filter media*. Typically, traditional disposable filter paper is used, however as an alternative, GILES offers an optional sustainable stainless steel filter screen, which is cleanable and reusable. This cleaning procedure should be performed **after each boil-out process and, at a minimum, once per day of operation. Doing so will help to ensure optimum filter system performance.**

CAUTION Wear thermal protection to protect hands from potentially hot parts.

NOTE: We recommend use of **Simple Green® Crystal Foaming Spray Cleaner/Degreaser** for general cleaning of fryers and parts. It is readily available from GILES distributors and dealers, as well as many national retail outlets. It is non-toxic, safe for use on all metal surfaces, and is NSF approved.

1. Remove *filter pan* assembly from fryer as needed.
2. Remove **Cover** ① and **Crumb Screen Insert** ②. Dispose of any collected crumbs and clean both pieces using a non-detergent, non-toxic degreasing cleaner, and scrub with brush as needed. Rinse with hot water spray and dry thoroughly.
3. Using the provided *crumb shovel*, remove the majority of filter sediment which is accumulated on the surface of the filter media, particularly around the **Hold-down Frame** ③. This will help to avoid allowing sediment to fall into the pan bottom, getting into hoses and potentially causing the pump to clog.
4. Turn the **four (4) Locking Levers** ④ on the *hold-down frame* to disengage it from the pan. Remove frame, clean with degreasing cleaner, and rinse thoroughly ... dry completely.
5. Grasp one end of the filter media ⑤ and carefully roll up, remove, and dispose ... avoid dropping filter sediment into pan.
6. Remove the ribbed filter media **Support Screen** ⑥ from the pan, clean with degreasing cleaner, and rinse thoroughly ... dry completely.

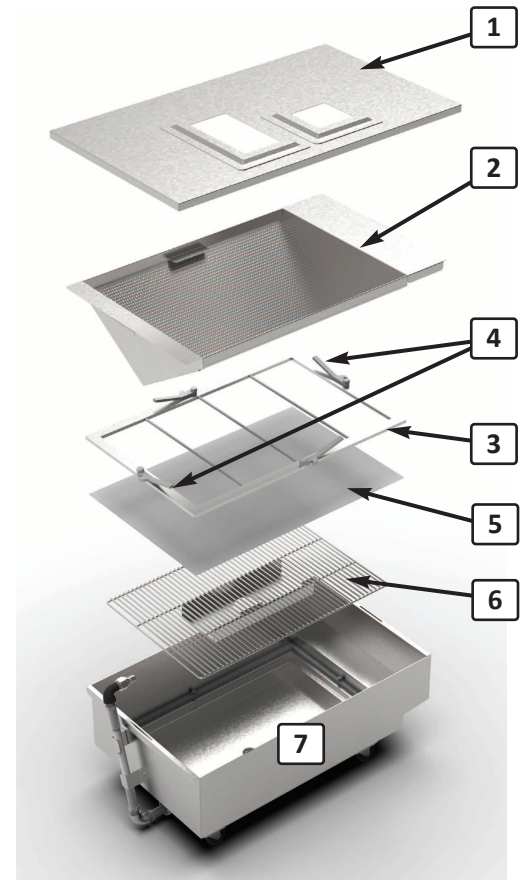

5.3 Cleaning the Filter Pan & Refreshing Filter Media - continued

7. Using a non-detergent, bio-degradable degreasing cleaner, such as **Simple Green® Crystal Foaming Cleaner**, thoroughly clean the *filter pan* ⑦. Rinse thoroughly with hot water spray and dry completely. Flush out the hoses to remove any filter sediment that may have gotten into them, then be certain that all residual water is drained out.
8. Ensure that all parts are completely dry. Reassemble *filter pan* assembly as shown, using fresh filter media. **Two (2) sheets of properly sized filter paper are required ...** lay it on top of *ribbed support screen*. Be sure that media is the correct size and properly installed under the *hold-down frame* ③ ... ensure that all *four (4) locking levers* are securely engaged with the hold-down studs.
9. Position assembled *filter pan* under fryer and re-connect hose to the fryer *filter pan coupling* ⑧ (push in slip-ring while inserting hose fitting). The connection must be tight and secure for proper operation.

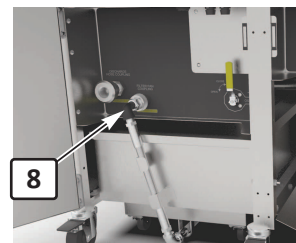

Optional Filter Screen Note:

When choosing to use the sustainable **Stainless Steel Filter Screen**, purchased separately from *Giles*, please follow the usage and cleaning instructions provided with the item. ***This item is an alternative substitute for filter paper and is NOT to be used in addition to filter paper.*** With proper cleaning and care, the screen should provide many months of dependable service.

Thoroughly wash and clean the screen periodically ... wash using **ONLY** clean hot water and a stiff bristle brush. **DO NOT** use soaps or other cleaners, as it will be almost impossible to rinse away all cleaner residue, which could subsequently contaminate cooking oil. Shake off excess water and blot dry with clean towel (ideally screen should dry overnight) before reinstalling.

Notes:

6. Troubleshooting

This section provides a reference guide for resolving problems that may arise when operating the equipment. The following information is intended to primarily aid service technicians in accurately diagnosing and correcting issues. The most common issues are discussed here. However, if you encounter problems that are not addressed, **Giles Technical Service representatives** may help identify and resolve the problem... **please call 800.554.4537 or email services@gfse.com.**

When troubleshooting problems, always use a process of elimination starting with the simplest solution, then work through to the most complex. Historically, many problems which have been reported are operational or procedural in nature ... **DON'T OVERLOOK THE OBVIOUS** ... tripped circuit breaker, improper valve setting, etc. Always refer to the instructions and procedures explained in previous sections of this manual.



Inspection, testing and repair of electrical circuitry and components should ONLY be performed by professional, qualified kitchen equipment service technicians.

6.1 Temperature Control System

Problem	Probable Cause	Corrective Action
Fryer will not turn [ON]. POWER light on control panel is not ON.	A. Circuit breaker tripped in the facility electrical panel.	Check for tripped circuit breaker.
	B. Blown fuse in fryer.	Check fuses, replace as needed (inside cabinet, upper right-hand corner).
	C. Power switch is faulty.	Call for service.
Controller does not power up. POWER light on control panel is ON.	A. Blown controller power fuse.	Call for service.
	B. Controller has failed.	Call for service.
Fryer does not heat. Control panel POWER light ON. Control panel amber HEAT light OFF. Controller HEAT indicator ON & PREHEAT displayed on controller screen.	A. HEAT switch on control panel is in the [OFF] position.	Place switch in [HEAT] position.
Fryer does not heat. Control panel POWER light ON. HEAT switch in [HEAT] position. Control panel amber HEAT light OFF. Controller HEAT indicator OFF. *Alarm may be sounding.	A. Power-up procedure not completed. "POWER FAILURE" msg still showing.	Press [START] key to enter PREHEAT mode.
	B. Actual oil temperature is already higher than the controller setpoint.	Verify temperature setting. After a boil-out cycle, the setting automatically changes to 50°F.
	C. "DRAIN OPEN" msg showing w/alarm	Verify that the drain valve is fully closed.
	D. Controller is faulty	Call for service.
	E. Temperature sensor faulty Er13 msg displayed	Call for service.
	F. Contactor is failed	Call for service.
	G. HEAT switch is faulty	Call for service.
Fryer does not heat. Control panel POWER light ON. HEAT switch in [HEAT] position. Control panel amber HEAT light ON. Controller HEAT indicator is ON.	A. Heating element circuit breaker has tripped.	Reset circuit breaker (located on rear of unit behind a removable cover).

6.1 Temperature Control System - continued		
Problem	Probable Cause	Corrective Action
Fryer heating slowly (slow temp recovery). Amber HEAT light remaining ON, does not cycle.	A. Improper cooking procedures.	Refer to Operation Manual.
	B. Heating element is failing.	Call for service.
	C. Contactor failing.	Call for service.
	D. Loose heating element wiring.	Call for service.
	E. Incoming voltage too low.	Call for service ... electrician required.
Fryer heating slowly, heat turning OFF & ON continuously.	A. Temp probe too close to (or touching) heating element.	Call for service.
	B. Controller has failed.	Call for service.
Oil temperature erratic.	A. Temperature probe is faulty.	Call for service.
	B. Contactor is failing.	Call for service.
	C. Controller is failing.	Call for service.
	D. Heating element wiring loose.	Call for service.
Cooking oil is smoking.	A. Oil is old, used too long.	Remove oil, perform boil-out, refill with fresh oil.
	B. Cooking temperature too high	Verify proper temp setting for food item.
	C. Heating elements dirty	Clean vat using boil-out procedure.
	D. Heating element is faulty.	Call for service.
	E. Low oil level	Maintain oil level between FULL & ADD.
Fryer continues heating ... high-limit safety trips. POWER light ON. HEAT switch in [HEAT] position. Amber HEAT light ON. Controller HEAT indicator ON. Control panel red HI-LIMIT light turns ON.	A. Temperature probe has failed.	Call for service.
	B. Contactor has malfunction ... stuck in closed position.	Call for service.
	C. Controller has failed.	Call for service.
High-limit safety trips before reaching setpoint. POWER light ON. HEAT switch in [HEAT] position. Amber HEAT light ON. Controller HEAT indicator ON. Control panel red HI-LIMIT light ON.	A. Hi-Limit thermostat has failed.	Call for service..
	B. Hi-limit probe is misaligned, too close to heating element.	Call for service.
	C. Power line spike causing false hi-limit trip.	Call for service.
	D. Oil is cold false HI-LIMIT during initial heating of the day.	Continuously stirring while heating cold oil will help prevent this issue.

6.2 On-Board Oil Filtration Problems		
Problem	Probable Cause	Corrective Action
Cook vat does not drain.	A. Excessive crumbs or residue clogging drain.	Use provided round-bristle brush to clear drain.
Oil does not circulate or return to refill vat when filtering.	A. Oil is too cold to pump.	Must manually remove thickened oil from filter pan.
	B. Filter pan is packed with excessive cooking residue, pump cannot drawing.	Manually remove oil, clean filter pan & refresh filter media.
	C. Filter pan assembled incorrectly.	Check that filter pan is assembled properly.
	D. Air leaking into system plumbing (hoses, fittings, etc.)	Check that filter pan hose connections are secure.
	E. Filter pump is clogged, or damaged.	Call for service.
	F. Filter pump motor has overheated & tripped the internal thermal overload safety.	Allow pump to cool for about 45 mins to auto-reset overload safety, then retry. If this fails or continues happening, call for service.
Oil doesn't circulate or return to vat for refilling when filtering.	A. OIL RETURN valve inside cabinet is in the [CLOSE] position. <i>Pump shutdown due to high pressure.</i>	Move valve to the [OPEN] position. Pump should start after pressure is relieved.
	B. Pump switch on control panel has failed.	Call for service.
Waste oil will not discharge through connected hose.	A. OIL WAND valve inside cabinet is in the [CLOSE] position. <i>Pump shutdown due to high pressure.</i>	Move valve to the [OPEN] position. Pump should start after pressure is relieved. Be sure wand end is securely placed in disposal container.
	B. Discharge hose is improperly connected at coupling.	Check connection and retry.
Fryer connected to bulk waste oil handling system: Waste oil will not pump from filter pan to collection tank.	A. WASTE OIL valve inside cabinet is in the [CLOSE] position. <i>Pump shutdown due to high pressure.</i>	Move valve to the [OPEN] position. Pump should start after pressure is relieved.
	B. Oil line to collection tank is clogged. <i>Pump shutdown due to high pressure.</i>	Call bulk system supplier for service.
	C. Bulk collection tank may be full.	Call waste oil collection company for pick-up service.

6.3 Oil Top-Off System Problems		
Problem	Probable Cause	Corrective Action
Top-Off does not pump oil to vat.	A. Fresh oil supply is empty ... <i>Saddle Tank</i> or <i>Jug-In-Box</i> on banked unit.	Refill tank with fresh oil or replace J.I.B supply jug.
	B. Top-off oil line has clogged.	Check lines, clear if needed.
	C. Top-off pump has failed.	Call for service.
	D. Air leaking into system.	Check all connections, incl. jug cap.
	E. OIL RETURN valve not positioned in [OPEN] position.	Place valve in the [OPEN] position.
	F. Pump control pushbutton switch on control panel has failed.	Call for service.
Fryer connected to bulk fresh oil supply system: Top-Off doesn't pump oil to vat.	A. Bulk oil fresh supply is exhausted.	Service the bulk fresh oil system to replenish supply.
	B. Bulk system internal pump has failed, or supply line has clogged.	Call system supplier for service.
	C. Electrical connections between the bulk system and the fryer has malfunctioned.	Call system supplier for service.
	D. Internal issue with the bulk system.	Call system supplier for service.

6.4 Filter Pump Problems		
Problem	Probable Cause	Corrective Action
Filter Pump will not start.	A. Pump switch on control panel has failed.	Call for service.
	B. Blown fuse in fryer with PUMP switch.	Check fuses, replace as needed (inside cabinet, upper right-hand corner).
	C. Pump head has seized.	Call for service.
Filter Pump starts, runs briefly, then stops.	A. To avoid blown seals, sensor has shutdown pump due to high pressure .	Pumping against closed valve or solid blockage. Verify valve operation. Call for service, as required.
	B. Filter pump motor has overheated & tripped the internal thermal overload safety.	Allow pump to cool for about 45 mins to auto-reset overload safety, then retry. If this fails or continues happening, call for service.
Pump runs, making excessive grinding noise.	A. Pump head becoming clogged with filter residue.	Call fo service.
	B. Water or used boil-out solution has been run through pump.	Call for service.

6.5 Basket Lift System (if Equipped)		
Problem	Probable Cause	Corrective Action
<i>Basket Lift will not operate.</i>	A. LIFT switch on control panel is in the [OFF] position.	Place switch in [LIFT] position to enable lifts.
	B. Fryer is in PREHEAT mode.	Lifts cannot be operated manually until cooking temp has been reached & controller is in READY state.
	C. Not following proper procedure.	Refer to <i>Operation Manual</i> for instructions.
	D. Controller has failed, no output voltage to lift.	Call for service.
	E. Basket lift micro-switch is out of adjustment or faulty.	Call for service.
	G. Basket lift motor or gearbox has locked up.	Call for service.
<i>Lift moves very slowly, struggles to raise.</i>	A. Motor brake is stuck, not releasing.	Call for service.
	B. Motor or gearbox is beginning to fail.	Call for service.
<i>Lift vibrates or chatters excessively when running.</i>	A. Lift mechanism out of alignment, parts broken/failing, motor brake sticking or gearbox is failing	Call for service.
<i>Basket Lift will not remain in raised position ... drifts down.</i>	A. Lift motor brake has failed or is failing, not fully engaging.	Call for service.



Notes:

7. Parts List

This section lists some of the various replacement parts that are available for the appliance. This is not an all inclusive listing; please contact an authorized *Giles* representative or service agent concerning other parts that may be field-replaceable.

7.1 Parts Ordering & Service Information

As an equipment manufacturer, *Giles* does not sell service parts direct. Parts are available through authorized service agents, part distributors, and/or kitchen equipment dealers. If assistance with sourcing parts or equipment repair service is required, please contact a *Giles Manufacturer's Representative* to assist with locating a parts source or authorized service provider near you. For further assistance you may contact **GILES Technical/Customer Service Support** as follows:

IN THE UNITED STATES & CANADA call: 800.554.4537

ALL OTHERS call: 334.272.1457

Normal business hours are 8:00 AM to 5:00 PM Central Time ... calls are handled by an automated answering system, so please follow the recorded instructions.

Website: www.gfse.com or e-mail services@gfse.com.

The goal at *Giles* is to provide the best service and customer support in the industry. To help us accomplish this, please become familiar with the equipment specification data and refer to it when calling. The information can be found on a data/serial label similar to the one below, which will be attached to a rear cabinet panel or at a location inside the cabinet (each unit of a banked system).

MODEL/MODELE		SERIAL NO/NO DE SERIE		
VAC/VCA	HZ	PHASE	AMPS	WATTS
DESCRIPTION/DESCRIPCIÓN				
GILES ENTERPRISES 1-800-554-4537 2750 GUNTER PARK DRIVE WEST • MONTGOMERY • ALABAMA • 36109				

An area is provided inside this Manual's front cover for recording this information as a quick reference.

7.2 Control Panel - Single Unit & Banked System Main Unit

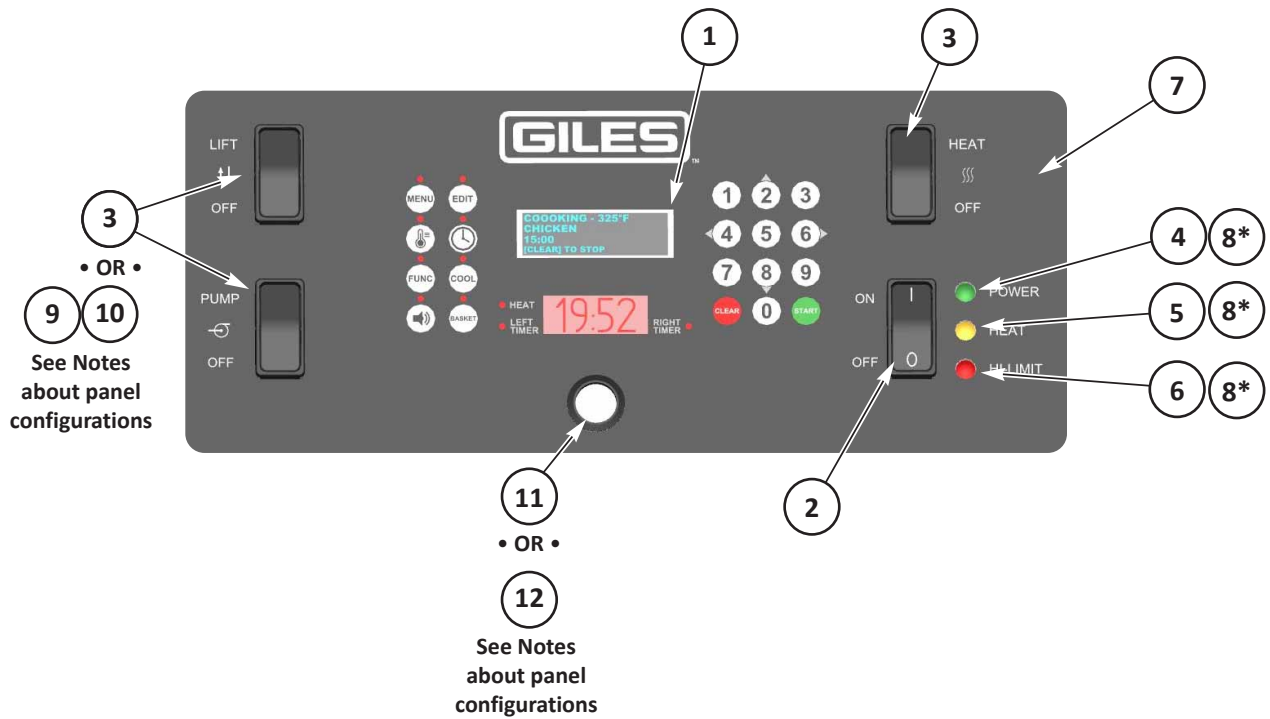

* Not Shown

7.2 Control Panel - Single Unit & Banked System Main Unit - continued

ITEM	PART NO.	QTY	DESCRIPTION
1	21374	1	CONTROLLER, CC10, DUAL TIMER
2	21190	1	SWITCH, ROCKER, ON-OFF, 250V, 20A, DPST
3	21052	3 / 2 / 1	SWITCH, ROCKER ,ON-OFF-ON, 250V, 20A, DPDT
4	20398	1	INDICATOR LIGHT, GREEN, 250VAC
5	20399	1	INDICATOR LIGHT, ORANGE, 250VAC
6	20402	1	INDICATOR LIGHT, RED, 250VAC
7	66126	1	LABEL, CONTROL PANEL, CC10, GBF
8*	20307	3	RETAINING CLIP, INDICATOR LIGHT
9	20621	1 / 2	PLUG, SWITCH CUT-OUT (for units <i>WITHOUT</i> #3 installed)
10	41454	1 / 2	GASKET, SWITCH HOLE PLUG (for units <i>WITHOUT</i> #3 installed)
11	21555	1 / -	SWITCH, PUSH-BUTTON, MOMENTARY, 10A
12	21556	1 / -	PLUG, PUSH-BUTTON SWITCH

NOTE:

- PUMP switch (item #3) not installed in panel of add-on units of banked system ... replaced with (1) Item #9 + (1) Item #10 when not installed.
- LIFT switch (item #3) not installed in panel if unit is not equipped with optional basket lifts ... replaced with (1) Item #9 + (1) Item #10 when not installed.
- Push-button switch (item #11) installed only when unit is equipped with *Vat Top-Off and/or Bulk Fresh Oil Option* ... if not installed, replaced with Plug (item #12). Switch is only installed on (1) unit of a banked system, as needed.

* Not Shown

7.3 Front Header Component Box (behind Control Panel of Each Unit)

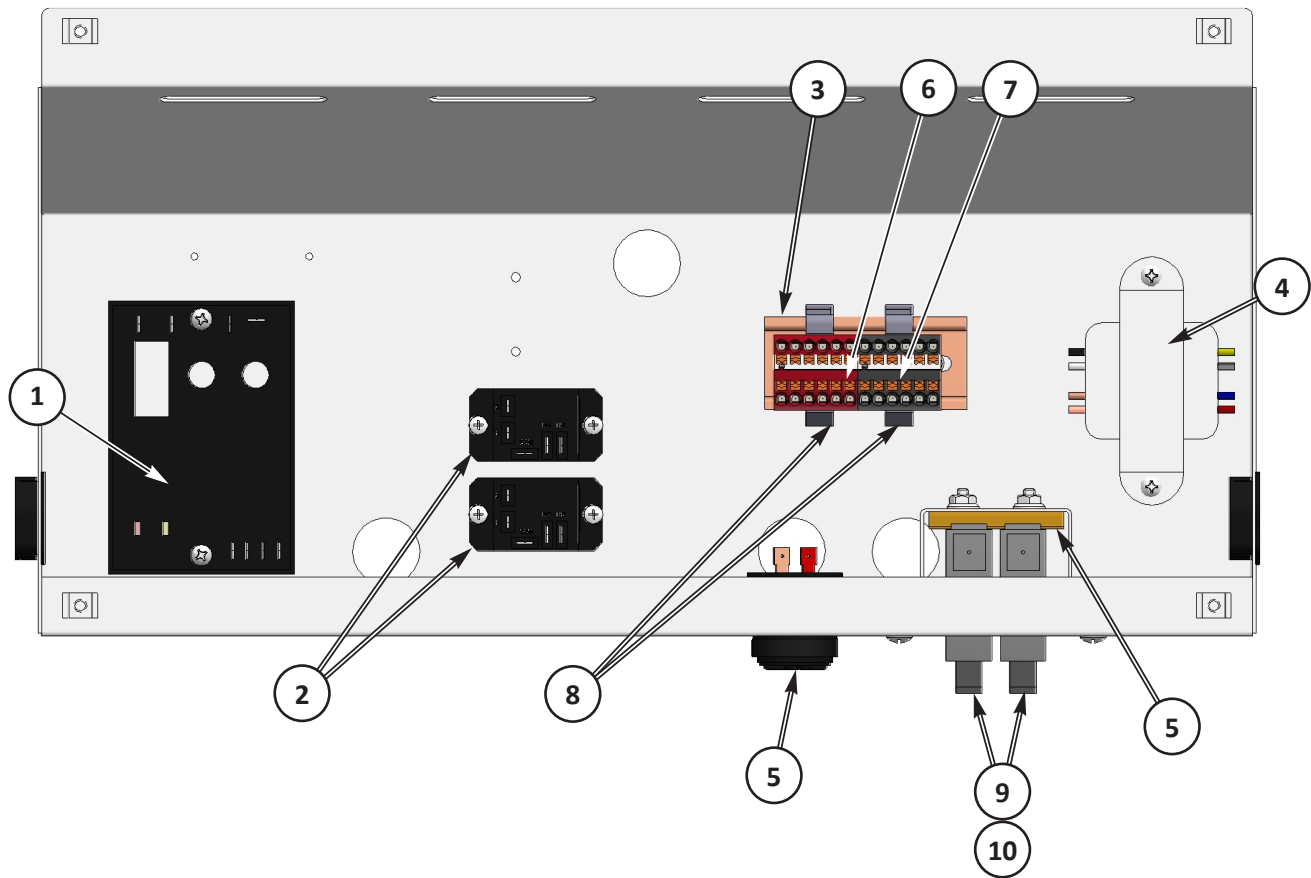

7.3 Front Header Component Box (behind Cntrl Panel of Each Unit)- cont.

ITEM	PART NO.	QTY	DESCRIPTION
1	21592	1	LIMIT CONTROL, SAFETY, 450-DEG F, DUAL
2	21203	2	RELAY, SPDT-NO-NC, 240VAC
3	37585	1	DIN RAIL, TERMINAL BLOCK MOUNT, 3.0"
4	20366	1	TRANSFORMER, 20VA, 115/230V, 50/60HZ
5	22976	1	AUDIOALARM, CONTINUOUS, 2-12 VDC
6	21509	1	DIST. BLOCK, 12-PL, 12-26 AWG, RED
7	21510	1	DIST. BLOCK, 12-PL, 12-26 AWG, BLACK
8	21496	2	END BRACKET CLIP, DIN RAIL, PTFIX, NS-35
9	20411	2	FUSE HLDR, DIN MOUNT, 690V, 32A
10	21693	2	FUSE, 15A, CC, 1.5"
11	98335	1	DIN RAIL, 2"

7.4 Lower Cabinet - Single Unit or Banked System Main Unit

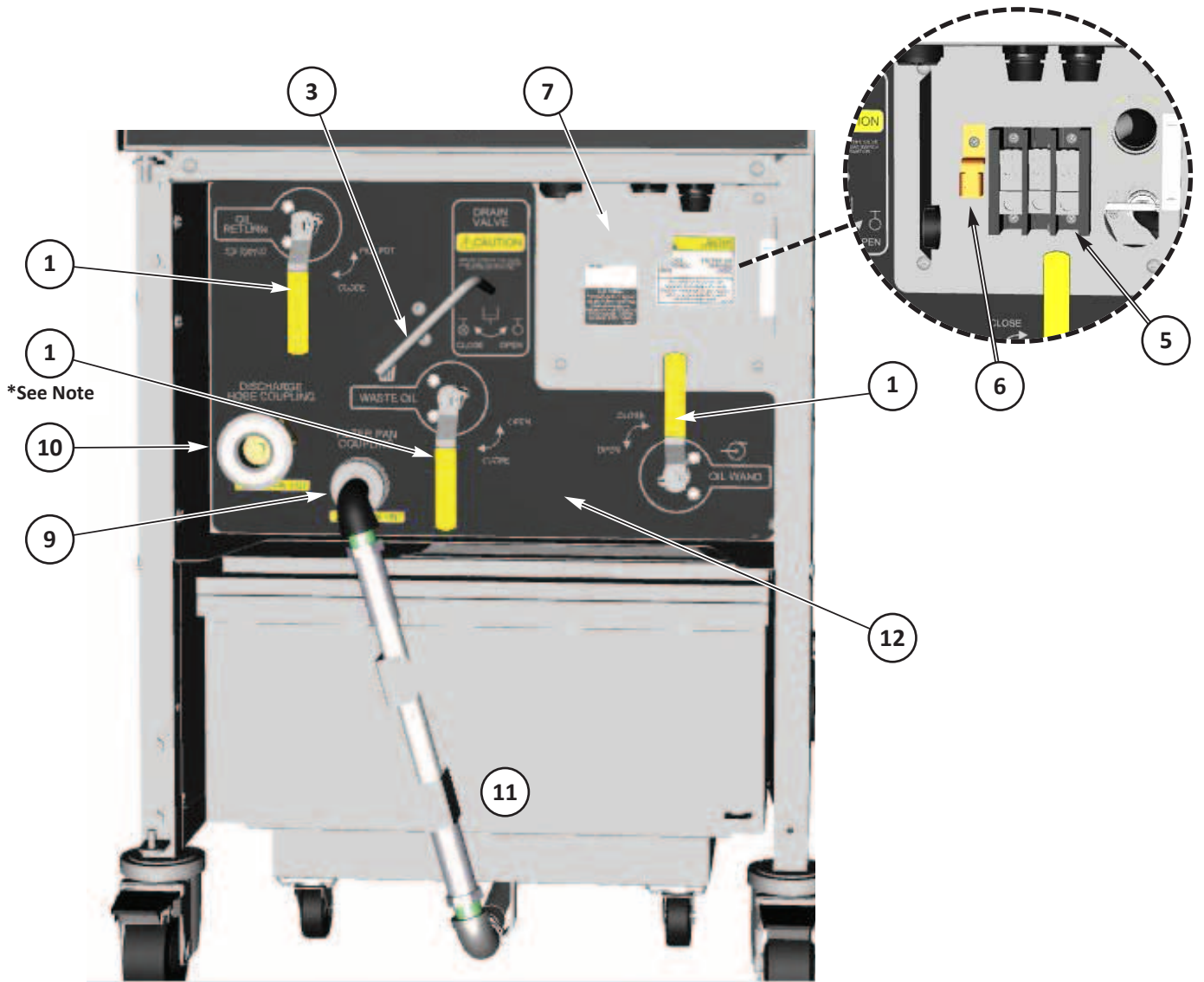

*See Note

***NOTE:** WASTE valve not present unless unit is equipped with the bulk *Waste Oil Handling* option.

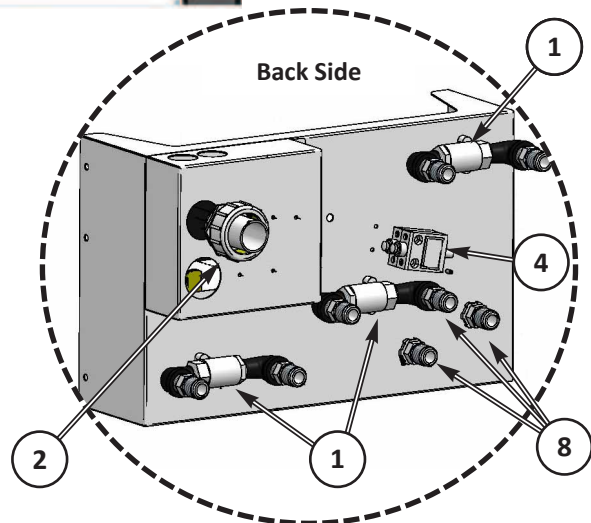

7.4 Lower Cabinet - Single Unit or Banked System Main Unit - continued

ITEM	PART NO.	QTY	DESCRIPTION
1	40784	3	BALL VALVE, 1/2, S/S w/NON-STICK SEALS
2	20527	1	CONDUIT CONNECTOR, 1-1/4 FLEX, STRAIGHT, NON-METAL
3	97188	1	DRAIN VALVE HANDLE
4	21386	2	DRAIN LIMIT SWITCH, SPDT, PREWIRED
5	21164	1	TERMINAL BLOCK, POWER DISTRIBUTION
6	21051	1	GROUND LUG
7	96173	1	COVER, ELECTRICAL SERVICE BOX <i>(ORDER NEW LABELS, IF REPLACED)</i>
8	40889	8	ADAPTOR, 1/2-COMPRESS TO 1/2-NPT
9	41900	1	QUICK-CONNECT/DISCONNECT COUPLING, FEMALE, FILTER PAN
10	41699	1	QUICK-CONNECT/DISCONNECT COUPLING, FEMALE, DISCHARGE HOSE
11	97325	1	COMPLETE FILTER PAN ASSEMBLY w/COVER
12	65673	1	LABEL, FRONT BRACE, SINGLE-MAIN UNIT

7.5 Lower Cabinet - Banked System Add-on Unit with J.I.B. Option

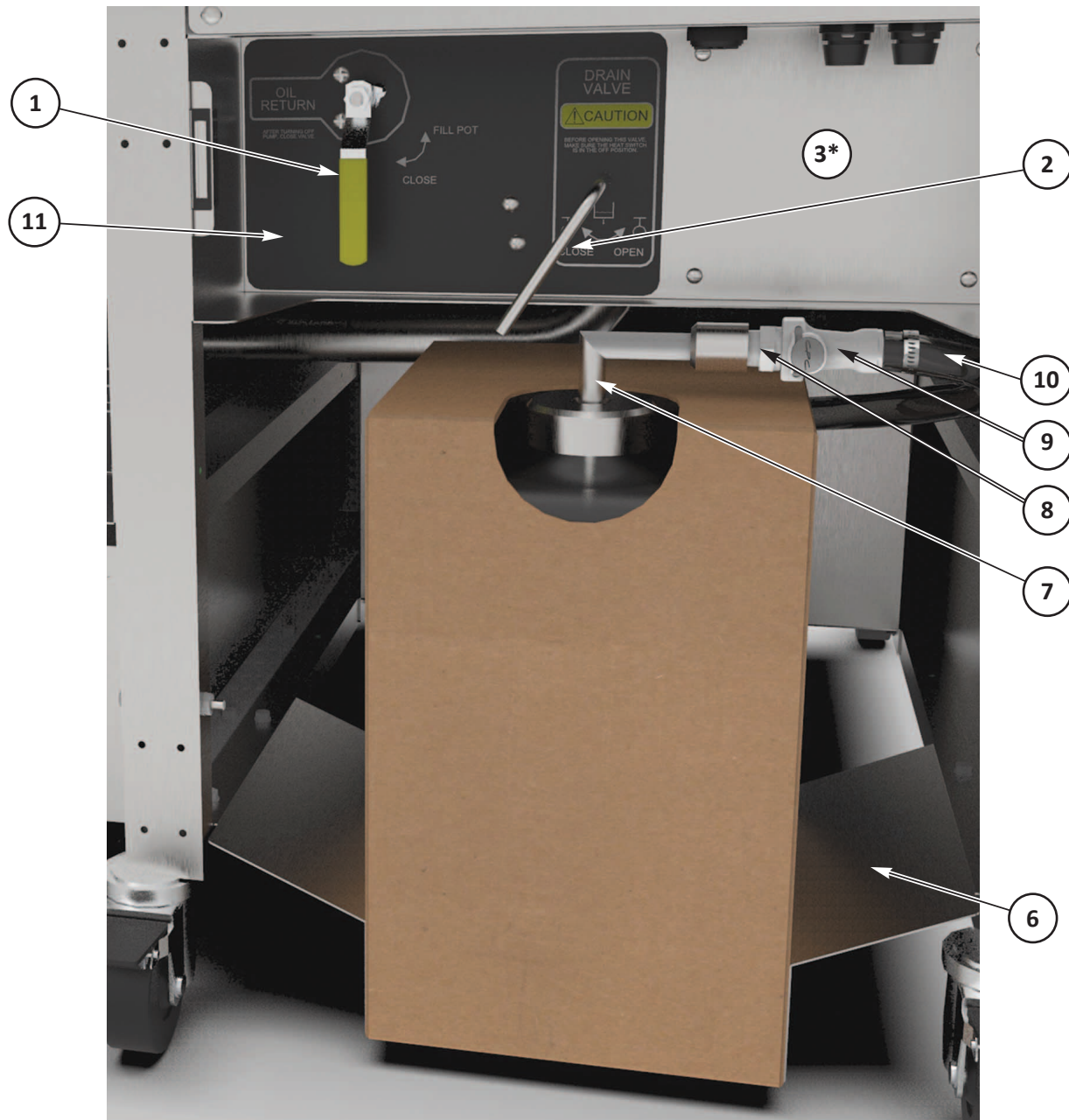
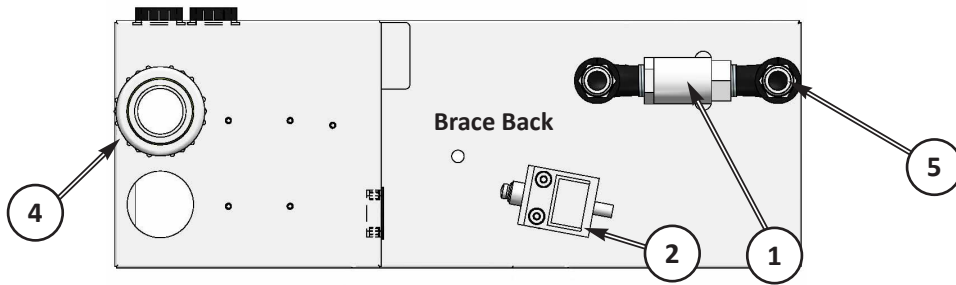

7.5 Lower Cabinet - Banked System Add-on Unit with J.I.B. Option - cont.

ITEM	PART NO.	QTY	DESCRIPTION
1	40784	1	BALL VALVE, 1/2, S/S w/NON-STICK SEALS
2	97188	1	DRAIN VALVE HANDLE
3*	96173	1	COVER, ELECTRICAL SERVICE BOX <i>(ORDER NEW LABELS, IF REPLACED)</i>
4	20527	1	CONDUIT CONNECTOR, 1-1/4 FLEX, STRAIGHT, NON-METAL
5	40889	2	ADAPTOR, 1/2-COMPRESS TO 1/2-NPT
6	96146	1	J.I.B. BRACE <i>(WITH JUG-IN-BOX OPTION ONLY)</i>
7	96158	1	DRAW TUBE, WELD ASSY, J.I.B. <i>(WITH JUG-IN-BOX OPTION ONLY)</i>
8	41379	1	COUPLING, MALE, PLASTIC, 1/2 NPT <i>(WITH JUG-IN-BOX OPTION ONLY)</i>
9	41380	1	COUPLING, FEMALE, PLASTIC, 1/2 TUBE <i>(WITH JUG-IN-BOX OPTION ONLY)</i>
10	41429	36"	HOSE, PVC, 1/2 ID <i>(WITH JUG-IN-BOX OPTION ONLY)</i>
11	66304	1	LABEL, FRONT BRACE, ADD-ON, MANUAL UNIT

* See page #78-79 for Electrical Box detail.

NOTE:

- J.I.B. configuration is an on-board fresh oil supply for the optional Vat Top-Off system and is available only for banked units of 2 or 3 wells.
- Items 6, 7, 8, 9, 10 not present in unit without J.I.B. Top-Off Option.

7.6 Plumbing Components - Single Fryer

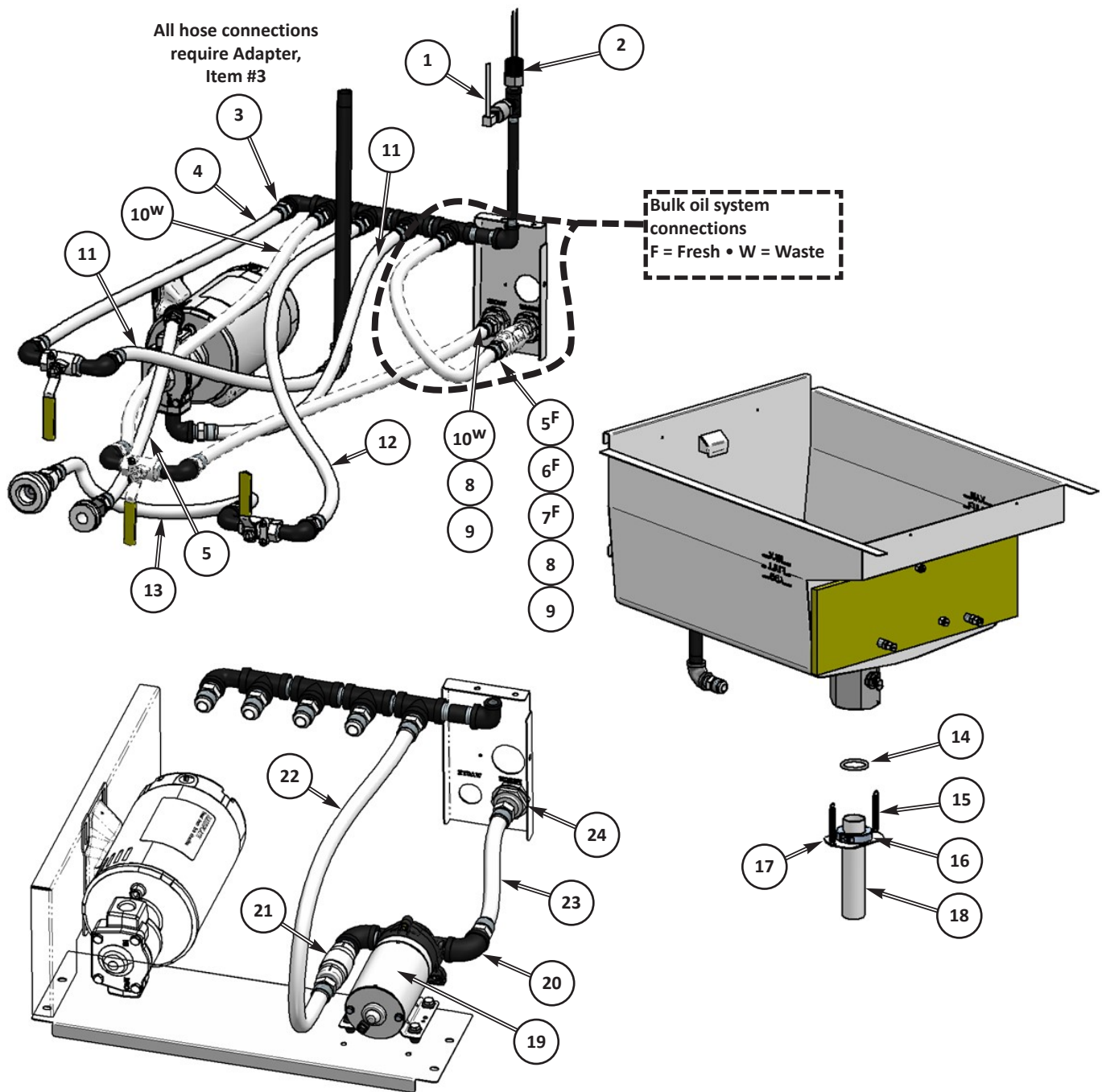

7.6 Plumbing Components - Single Fryer - continued

ITEM	PART NO.	QTY	DESCRIPTION
1	21440	1	TRANSDUCER, PRESSURE, 0-50 PSI
2	21434	1	PRESSURE SWITCH, 35 PSI, 10A
3	40889	VAR.	ADAPTOR, 1/2-COMPRESS TO 1/2-NPT
4	41081	1	HOSE, CORRUGATED, SS, 1/2 NPT X 30"
5	40909	1	HOSE, CORRUGATED, SS, 1/2 NPT X 15
BULK OIL SYSTEM CONNECTIONS ONLY: F = Fresh Oil • W = Waste Oil			
5 ^F	40909	1	HOSE, CORRUGATED, SS, 1/2 NPT X 15"
6 ^F	46712	1	CHECK VALVE, 1/2 NPT
7 ^F	43850	1	NIPPLE, CLOSE, 1/2 NPT, BLACK PIPE
8	46475	1 ^F +1 ^W	ADAPTER, QUICK SEAL, 1/2
9	41410	1 ^F +1 ^W	PLUG, PIPE, THREADED, 1/2 NPT <i>(Remove when system installed)</i>
10 ^W	41081	2	HOSE, CORRUGATED, SS, 1/2 NPT X 30"
11	41119	2	HOSE, CORRUGATED, SS, 1/2 NPT X 24"
12	41081	1	HOSE, CORRUGATED, SS, 1/2 NPT X 30"
13	40907	1	HOSE, CORRUGATED, SS, 1/2 NPT X 18"
14	40820	1	O-RING, DRAIN VALVE, 1-1/2"
15	41488	2	SPRING, EXTENSION, 1/2 OD X 2-1/2"
16	41487	1	COLLAR, SHAFT, 1-1/2" ID
17	97931	1	PLATE, SPRINGS, DRAIN TUBE
18	97918	1	DRAIN TUBE, SINGLE, GBF-70
ON-BOARD OIL TOP-OFF OPTION ONLY:			
19	21358	1	PUMP, TOP-OFF, SHURFLO, 208-240V
20	42100	2	ELBOW, 3/8 -1/2 BLACK REDUCING
21	46712	1	CHECK VALVE, 1/2 NPT
22	41119	1	HOSE, CORRUGATED, SS, 1/2 NPT X 24"
23	41079	1	HOSE, CORRUGATED, SS, 1/2 ID X 8"
24	46475	1	ADAPTER, QUICK SEAL, 1/2

7.6.1 Plumbing Components - Double Bank Fryer

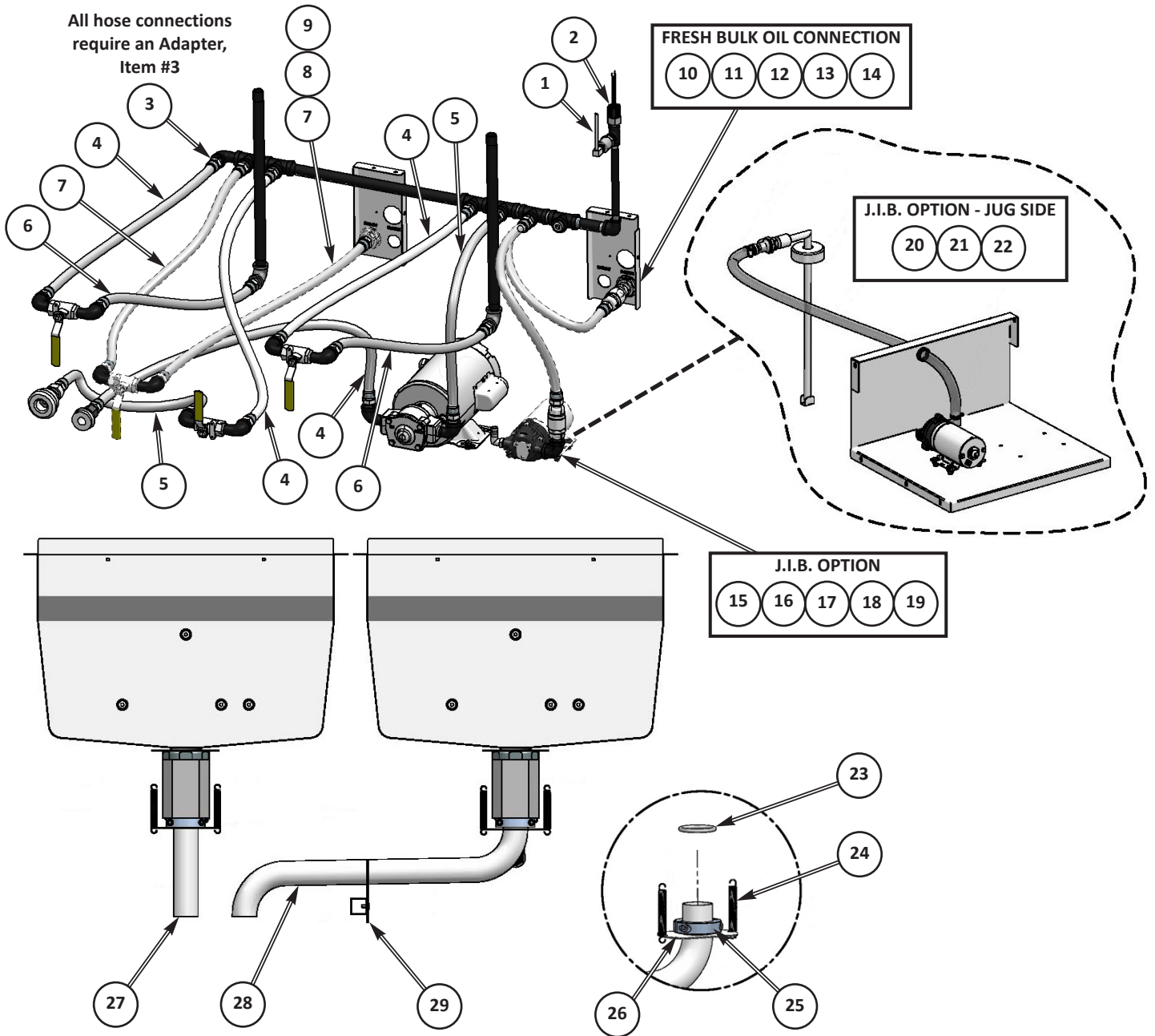

7.6.1 Plumbing Components - Double Bank Fryer - continued

ITEM	PART NO.	QTY	DESCRIPTION
1	21440	1	TRANSDUCER, PRESSURE, 0-50 PSI ... <i>CABLE = P/N 21357 (AUTOMATED UNITS ONLY)</i>
2	21434	1	PRESSURE SWITCH, 35 PSI, 10A
3	40889	VAR.	ADAPTOR, 1/2-COMPRESS TO 1/2-NPT
4	41081	4	HOSE, CORRUGATED, SS, 1/2 NPT X 30"
5	40907	2	HOSE, CORRUGATED, SS, 1/2 NPT X 18"
6	41119	2	HOSE, CORRUGATED, SS, 1/2 NPT X 24"
OPTIONAL BULK OIL SYSTEM CONNECTIONS ONLY: WASTE OIL TANK			
7	41081	2	HOSE, CORRUGATED, SS, 1/2 NPT X 30"
8	46475	1	ADAPTER, QUICK SEAL, 1/2
9	41410	1	PLUG, PIPE, THREADED, 1/2 NPT <i>(Removed when connected to system)</i>
OPTIONAL BULK OIL SYSTEM CONNECTIONS ONLY: FRESH OIL SUPPLY			
10	40909	1	HOSE, CORRUGATED, SS, 1/2 NPT X 15"
11	46712	1	CHECK VALVE, 1/2 NPT
12	43850	1	NIPPLE, 1/2, CLOSE, BLACK PIPE
13	46475	1	ADAPTER, QUICK SEAL, 1/2
14	41410	1	PLUG, PIPE, THREADED, 1/2 NPT <i>(Removed when connected to system)</i>
OPTIONAL ON-BOARD OIL TOP-OFF ONLY -JUG IN BOX (J.I.B.):			
15	21358	1	PUMP, TOP-OFF, SHURFLO, 208-240V
16	42100	1	ELBOW, 3/8 -1/2 BLACK REDUCING
17	41383	1	FITTING, ELBOW, 3/8NPT MALE TO 1/2 TUBE
18	43850	1	NIPPLE, 1/2, CLOSE, BLACK PIPE
19	40909	1	HOSE, CORRUGATED, SS, 1/2 NPT X 15"
20	96158	1	DRAW TUBE, WELD ASSY, J.I.B, GBF-70
21	41674	1	COUPLING,SWIVEL, SS, 1/2 NPT - 1/2 HOSE BARB
22	41429	36"	HOSE, PVC, 1/2 ID
VAT DRAIN PLUMBING:			
23	40820	2	O-RING, DRAIN VALVE, 1-1/2"
24	41488	4	SPRING, EXTENSION, 1/2 OD X 2-1/2"
25	41487	2	COLLAR, SHAFT, 1-1/2" ID
26	97931	2	PLATE, SPRINGS, DRAIN TUBE
27	97918	1	DRAIN TUBE, SINGLE, GBF-70
28	41478	1	DRAIN TUBE, FORMED, DOUBLE BANKED, GBF-70
29	97935	1	DRAIN TUBE BRACKET <i>(ATTACHES TO FRAME)</i>

7.7 Rear Cabinet - Single Unit

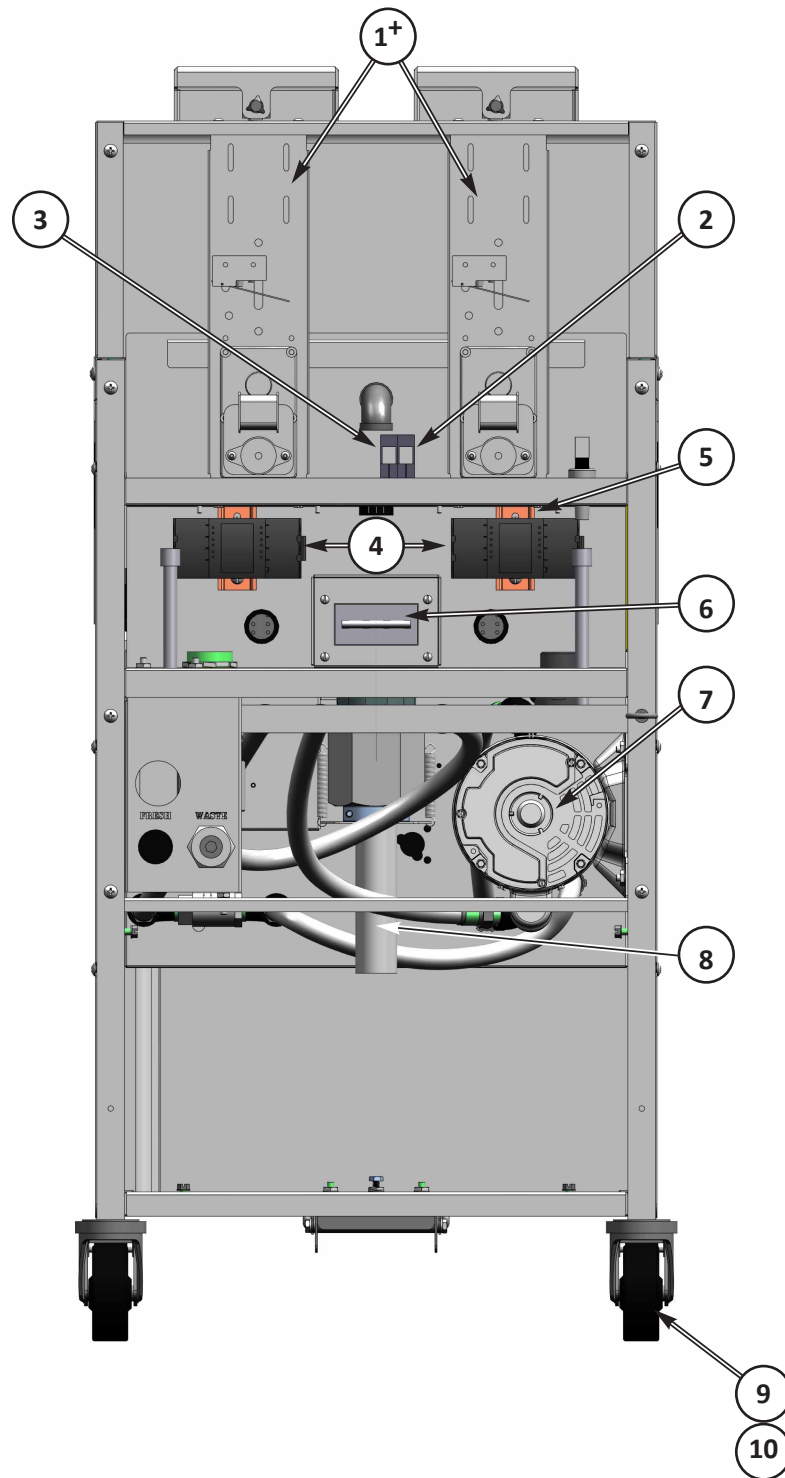

* Not Shown

+ Optional - installed with Basket Lift Option only

7.7 Rear Cabinet - Single Unit - continued

ITEM	PART NO.	QTY	DESCRIPTION
1+	35166	2	BASKET LIFT ASSEMBLY, COMPLETE <i>(OPTIONAL)</i>
2	21504	1	DISTRIBUTION BLOCK, 6-PL, 12-26 AWG, RED
3	21505	1	DISTRIBUTION BLOCK, 6-PL, 12-26 AWG, BLACK
4	21245	2	CONTACTOR, 60A, 3-PL, 100-250V COIL
5	37585	2	RAIL, TERMINAL BLOCK MOUNT, 3"
6	20513	1	CIRCUIT BREAKER, 277V, 50A, 6-POLE
7	71754	1	PUMP & MOTOR ASSEMBLY, 1/2 HP, 5-GPM
8	97918	1	DRAIN TUBE, SINGLE, GBF-70
9	40641	2	SWIVEL CASTER, 4.5", STEM MOUNT, W/O BRAKE (REAR)
10	40704	2	SWIVEL CASTER, 4.5", STEM MOUNT, W/BRAKE (FRONT)

* Not Shown

+ Optional - installed with Basket Lift Option only

7.8 Rear Cabinet - Double Bank Unit (with J.I.B. Option)

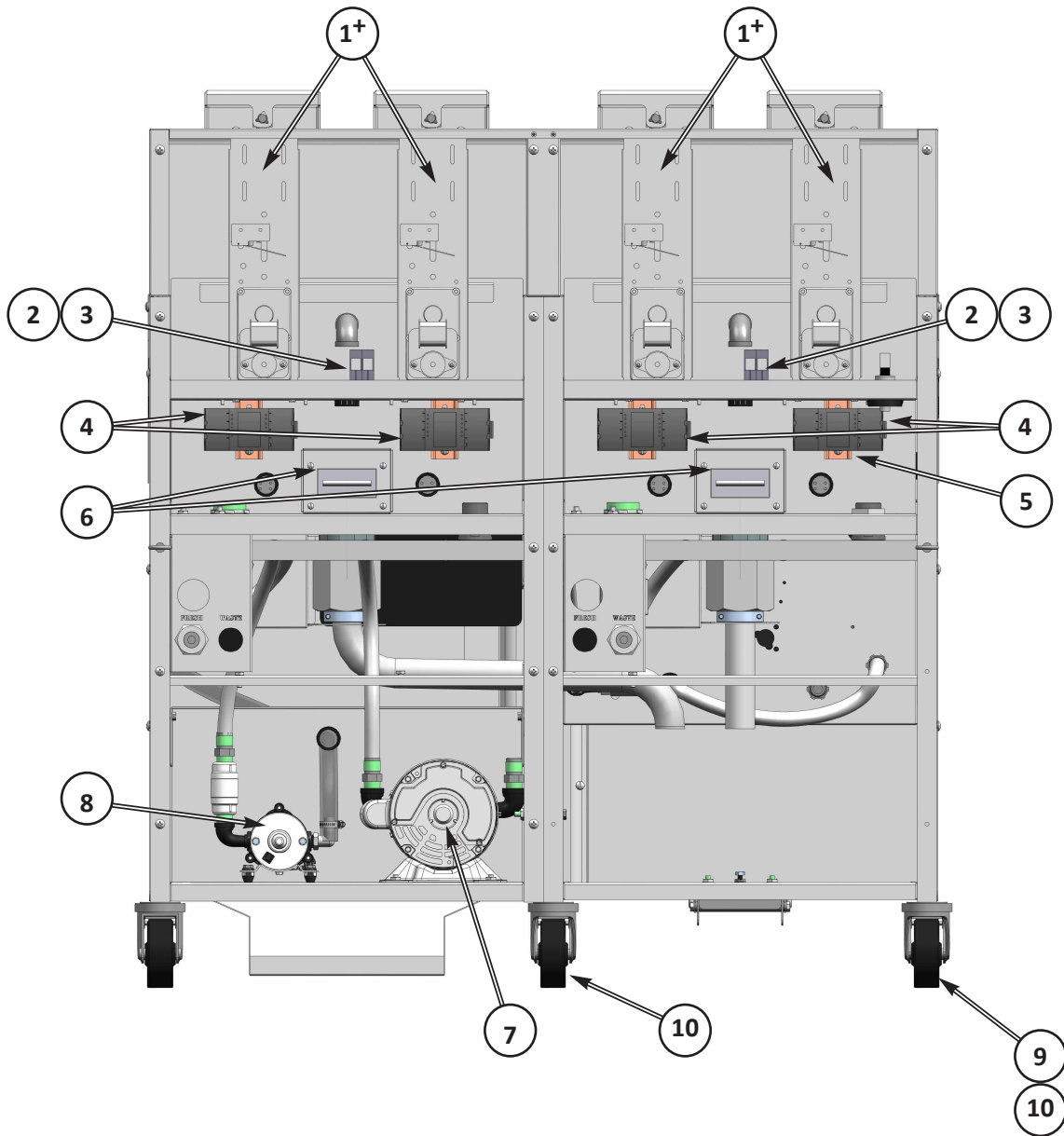

NOTE: Refer to *Section 7.6.1* for more plumbing & drain component detail.

+ Optional

7.8 Rear Cabinet - Double Bank Unit (with J.I.B. Option) - continued

ITEM	PART NO.	QTY	DESCRIPTION
1 ⁺	35166	2 or 4	BASKET LIFT ASSEMBLY, COMPLETE <i>(OPTIONAL)</i>
2	21504	2	DISTRIBUTION BLOCK, 6-PL, 12-26 AWG, RED
3	21505	2	DISTRIBUTION BLOCK, 6-PL, 12-26 AWG, BLACK
4	21245	4	CONTACTOR, 60A, 3-PL, 100-250V COIL
5	37585	4	RAIL, TERMINAL BLOCK MOUNT, 3"
6	20513	2	CIRCUIT BREAKER, 277V, 50A, 6-POLE
7	71754	1	PUMP & MOTOR ASSEMBLY, 1/2 HP, 5-GPM
8	21358	1	PUMP, TOP-OFF, SHURFLO, 208-240V <i>(Optional)</i>
9	40641	2	SWIVEL CASTER, 4.5", STEM MOUNT, W/O BRAKE (REAR)
10	40704	3	SWIVEL CASTER, 4.5", STEM MOUNT, W/BRAKE (FRONT)

NOTE: Refer to Section 7.6.1 for more plumbing & drain component detail.

⁺ Optional

7.9 Fry Vat Assembly (per Vat)

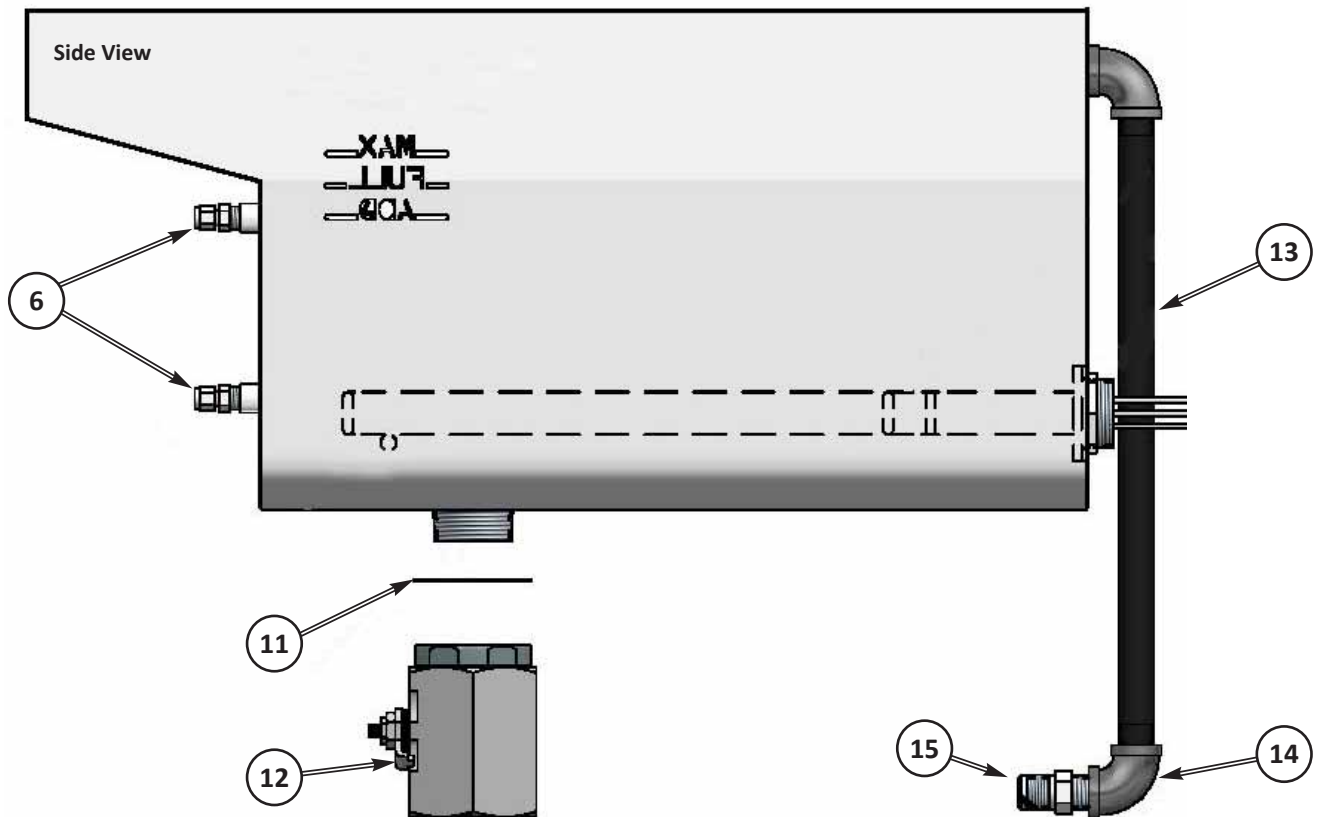
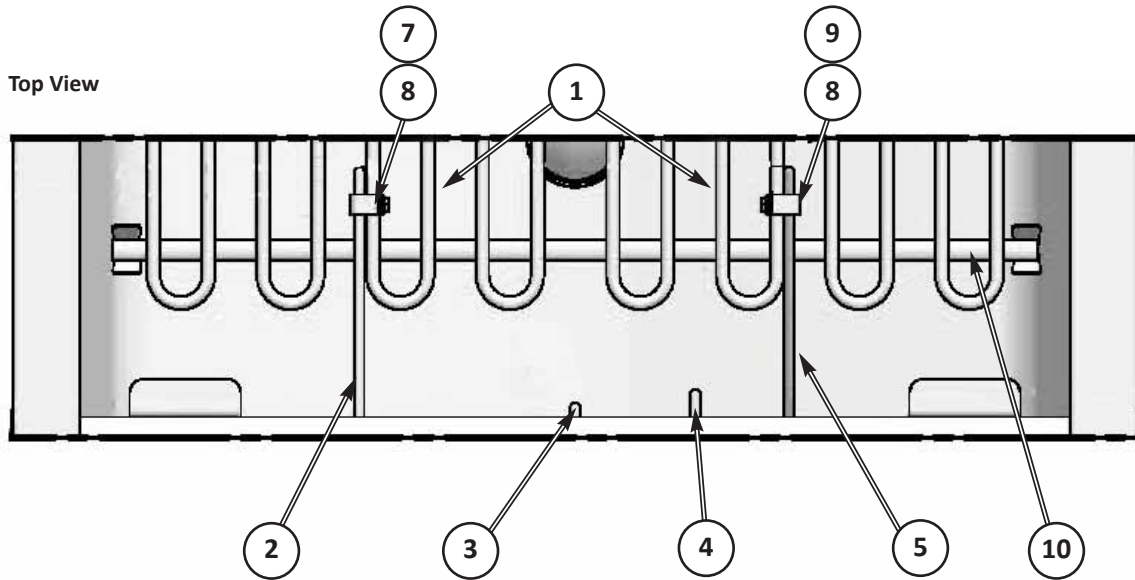

7.9 Fry Vat Assembly (per Vat) - continued

ITEM	PART NO.	QTY	DESCRIPTION
1	21447	2	ELEMENT, 208 V, 9975 W, FIREBAR
	21448	2	ELEMENT, 240 V, 9975 W, FIREBAR
	21449	2	ELEMENT, 480 V, 9975 W, FIREBAR
2	21596	1	THERMOCOUPLE- J, DUAL, 7-1/2", UNGROUNDED (<i>HI-LIMIT PROBE</i>)
3	20439	1	THERMOCOUPLE, J-TYPE, 3", UNGROUNDED (<i>ADD LEVEL PROBE</i>)
4	23900	1	THERMOCOUPLE, J-TYPE, 3", GROUNDED (<i>VAR. OIL TEMP PROBE</i>)
5	20362	1	THERMOCOUPLE, J-TYPE, 7-1/2", UNGROUNDED (<i>ELEMENT TEMP PROBE</i>)
6	45400	4	CONNECTOR, 0.190 ID, 1/4 NPT, SWAGELOCK
7	98148	1	ELEMENT BRACKET, HI-LIMIT, GAPPED
8	94462	2	STRAP, ELEMENT BRACKET
9	94834	1	ELEMENT BRACKET, FLUSH , ELEM. TEMP
10	97509	1	ELEMENT SUPPORT BAR
11	98265	1	PLATE, DRAIN TUBE SPRING HOOK
12	41432	1	VALVE, 1-1/2 NPT X 1-1/2 TUBE, FULL PORT
13	33634	1	NIPPLE, 1/2 NPT X 15-1/2", BLACK PIPE
14	42252	1	ELBOW, 90-DEG, 1/2NPT, S/S
15	40889	3	ADAPTOR, 1/2-COMPRESS TO 1/2-NPT

NOTE:

To avoid potential leaking, when replacing *Thermocouples* it is necessary to also replace the ferrule inside the *Swagelock* connector ...

Order part no. 45111.

7.10 Filter Pan Assembly

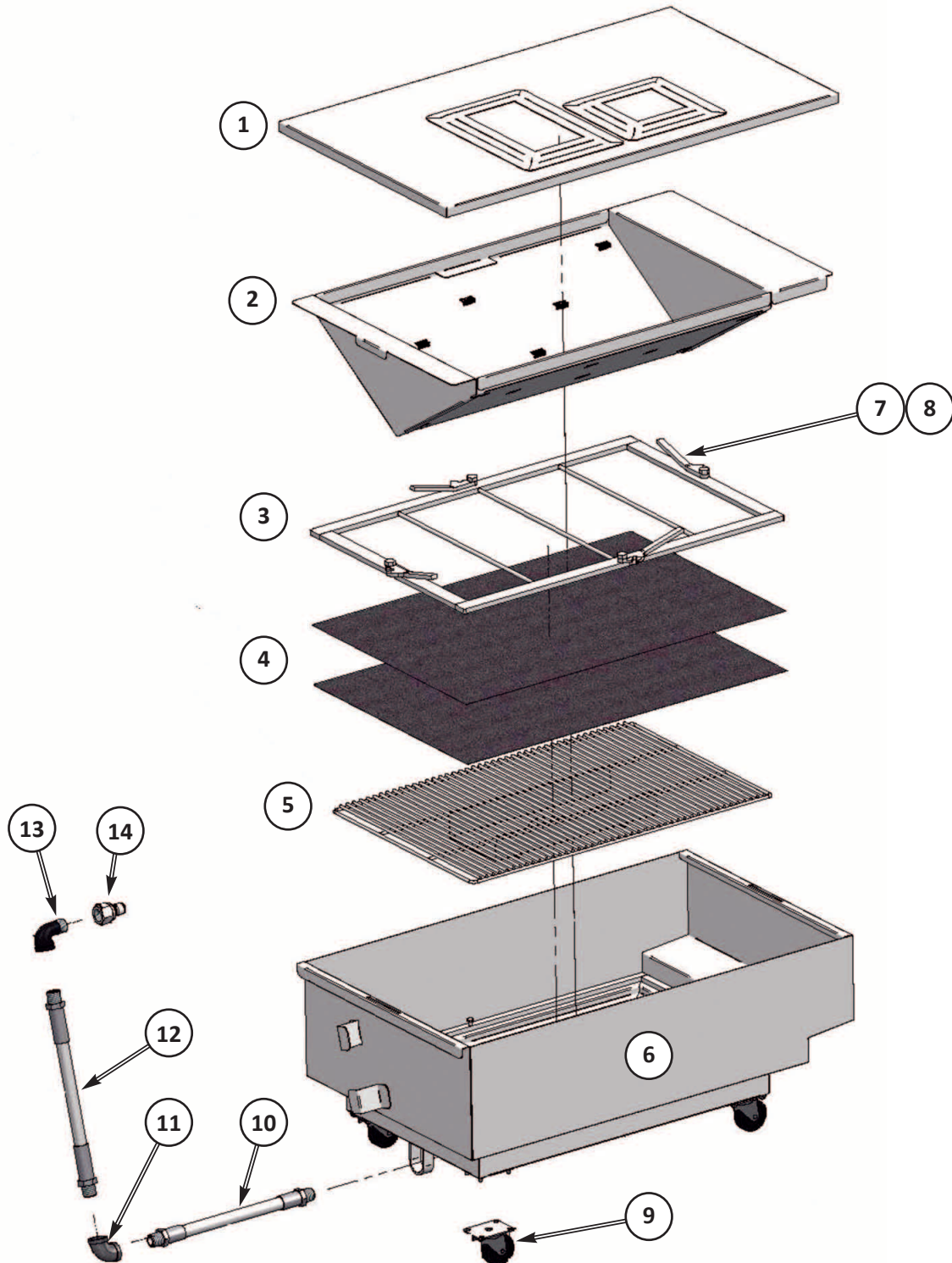

7.10 Filter Pan Assembly - continued

ITEM	PART NO.	QTY	DESCRIPTION
1	97930	1	FILTER PAN COVER ASSEMBLY
2	97334	1	CRUMB CATCHER SCREEN
3	30040-5	1	HOLD DOWN FRAME WELD ASSEMBLY <i>(WITHOUT LEVERS)</i>
4	60819	2	PAPER, FILTER, 16-1/4 X 24-1/4 <i>(TWO [2] SHEETS REQUIRED)</i>
5	98263	1	FILTER PAN MEDIA SUPPORT SCREEN
6	97326	1	FILTER PAN WELD ASSEMBLY
7	30040-4	4	STUD, LOCKING HANDLE, HOLDDOWN FRAME
8	54526	4	LOCKING HANDLE, HOLDDOWN FRAME
9	40649	4	CASTER, LOW PROFILE
10	41073	1	HOSE, 1/2 NPT X 12-1/2", SCT, SWIVEL FITTINGS
11	42252	1	ELBOW, 90-DEG, 1/2NPT, S/S
12	41074	1	HOSE, 1/2 NPT X 13", SCT, SWIVEL FITTINGS
13	42250	1	ELBOW, STREET, 1/2NPT, 90-DEG, BLACK PIPE
14	44150	1	MALE FITTING, 1/2NPT, QUIK-CONNECT/DISCONNECT, BRASS

NOTE: For complete replacement Filter Pan Assembly ... order Part No. 97325.

7.11 Baskets, Panels, & Covers

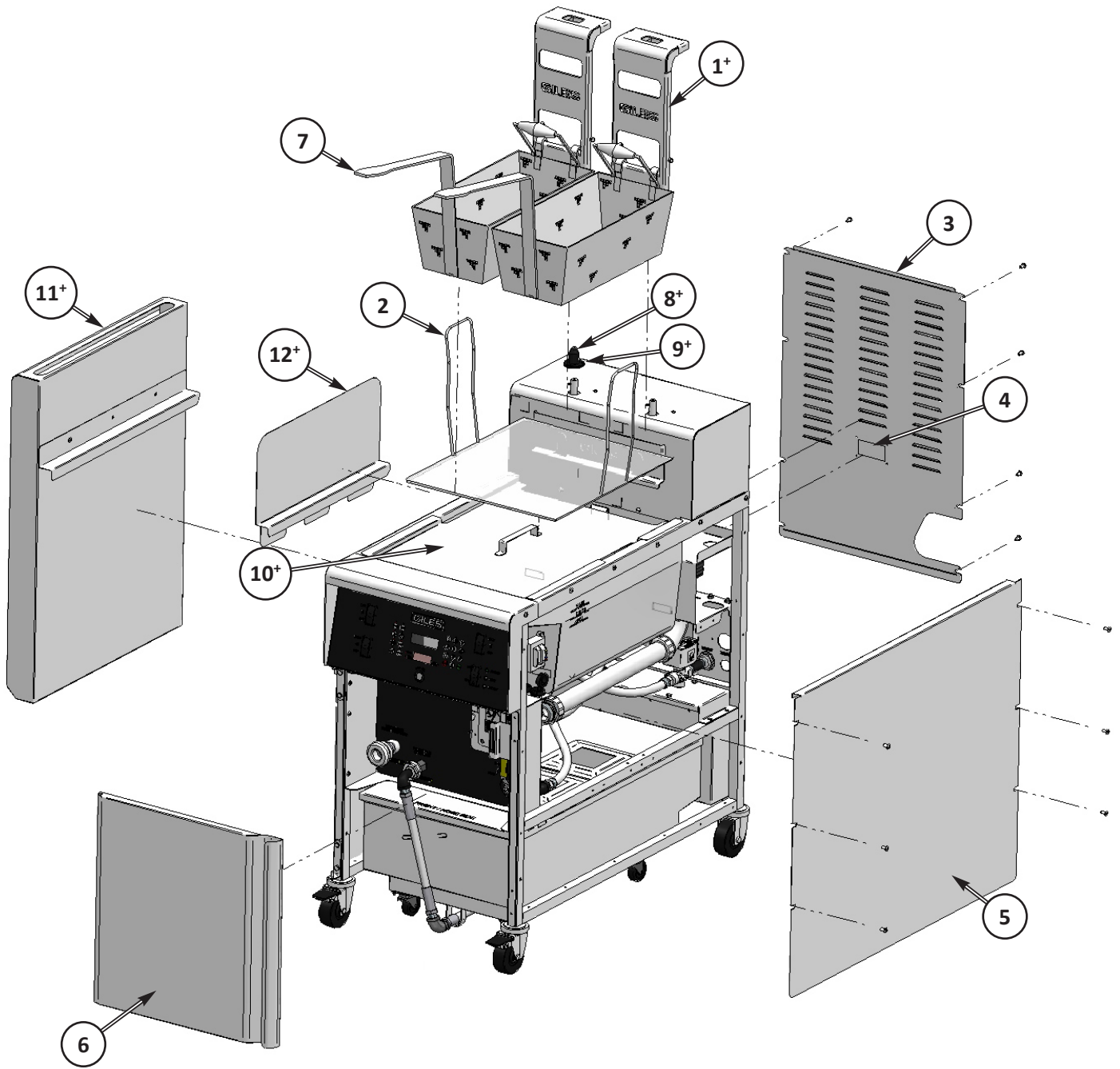

+ Optional

7.11 Baskets, Panels, & Covers - continued

ITEM	PART NO.	QTY	DESCRIPTION
1 ⁺	97212	2	BASKET CARRIER ASSEMBLY <i>(OPTIONAL)</i>
2	98997	1	VAT CRUMB SCREEN
3	97226	1	PANEL, CABINET BACK
4	92795	1	PANEL, BREAKER ACCESS
5	97169	1	PANEL, SIDE, LEFT
6	97530	1	CABINET DOOR
7	70420	2	COOK BASKET W/ REAR HANDLE
8 ⁺	21696	1	RADOME, WIFI ANTENNA COVER <i>(OPTIONAL, WIFI ONLY)</i>
9 ⁺	99668	1	GASKET, RADOME <i>(OPTIONAL, WIFI ONLY)</i>
10 ⁺	98995	1	POT COVER <i>(OPTIONAL)</i>
11 ⁺	72068	1	TOOL CADDY / SPLASH SHIELD <i>(OPTIONAL)</i>
12 ⁺	72095	1	SPLASH SHIELD <i>(OPTIONAL)</i>

⁺ Optional



Notes:

A. Connecting Optional KITCHENTRAC®



If you purchased a new *Giles* cooking appliance with optional, factory-equipped, **KITCHENTRAC® Remote Monitoring**, it comes to you ready for connection to the **KITCHENTRAC®** server, via your establishment's WiFi network. The app provides remote monitoring of equipment performance, productivity, menu trends, maintenance events and a multitude of other analytics pertaining to the appliance.

Three (3) levels of service are available when creating an account: **Basic, Business, & Enterprise**. **Basic** service is included with purchase of the **KITCHENTRAC®** option & provides limited functionality to *view data only*. **Business & Enterprise** levels require monthly service fees, but offer enhanced capabilities to remotely edit fryer settings & receive notification of problems via email or text. The **Enterprise** level even includes extensive monitoring by Giles Technical associates with automatic repair dispatch for warranty equipment.

A *WiFi Connection Manual, Form #66313* was shipped with your new equipment ... the following information also explains the process to connect controller to the **KITCHENTRAC®** server. After equipment is installed & checked out, follow these instructions precisely to get connected and begin experiencing the benefits of remote equipment monitoring.

Should you encounter any difficulties with the process, please contact **GILES Technical Services @ 800.554.4537** or email services@gfse.com.

A.1 Connecting WiFi Board to Wireless Router

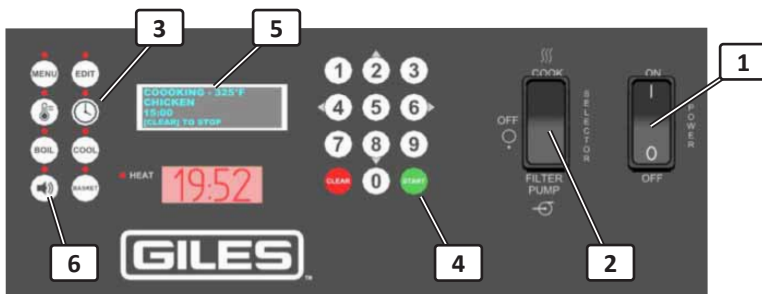

There are minor differences in control panel layout & configuration between appliance models.

IMPORTANT! *There must be a continuous open connection to the internet with a wireless WiFi router, which is within range of the monitored equipment. The password for the establishment router may be required.*

1. Place **POWER** switch ① to **[ON]** ... controller powers-up ... when alarm sounds, press **[ALARM]** key ⑥ to silence. Be sure to keep **SELECTOR** or **HEAT** switch ② in the **[OFF]** position throughout the process to prevent fryer heat from energizing.
2. Press **[TIME]** key ③ + **9 4 3 4** on keypad + **[START]** key ④.
The message **"WiFi SETUP PRESS [START]"** appears on the *upper display screen* ⑤ ... press **[START]** key.
3. The message **"SEARCHING FOR WIFI MODULE"** will appear on display screen.
If the WiFi module is not found within **10 seconds**, the message **"COMMUNICATIONS ERROR, CHECK CONNECTIONS"** will be displayed. Several issues can cause this error ... DIP switches on board are not set properly, cable is loose or disconnected, jumpers are missing, etc.
Turn **POWER** switch OFF ... check WiFi board & cables, then retry. If the error persists, call **Giles Technical Services @ 800.554.4537** for assistance.
4. When module is successfully found, the message **"WiFi MODULE FOUND, CONFIGURING"** appears on screen.

A.1 Connecting WiFi Board to Wireless Router - continued

5. The display screen will cycle through the messages below as configuration proceeds:
 - “WIFI MODULE FOUND, GETTING STATUS”
 - “STARTING CONFIG PORTAL”
 - “PORTAL ENABLED, CONNECT TO WIFI”

6. When “CONNECT TO WIFI” appears ... open *WiFi Settings* on a smart-phone [*Android or iPhone*] to display available networks ... select *KitchenTrac_Config*. This is the network being broadcast by fryer’s WiFi board for set-up.

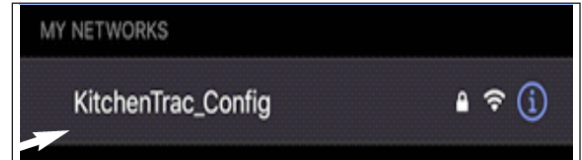

You will be prompted to enter a password ... password is **kitchentrac** (all lowercase).

7. The phone should open a *captive portal*.
NOTE: If the captive portal does not automatically open after about 30 seconds, open the phone’s web browser and type in IP address - 10.10.0.1 + enter.
8. On the phone, select the establishment’s WiFi network to which you are attempting to connect. Enter the router password (*if necessary*), then tap the “JOIN” button.

A.2 Establishing Communication with KITCHENTRAC® Server

1. A **PAIR CODE** must be communicated to **GILES Tech Service** while the person performing the connection procedure is on-site with access to the equipment.

If the previous steps were successful the **PAIR CODE** should be displayed on the fryer controller screen. The code regenerates to a different value every **15 minutes** ... whatever code is displayed while in contact with *Giles Services* is the one that must be registered before the app is active & monitoring begins.

If **PAIR CODE** does not appear, go to **step #2 of Section A.1** & try the connection process again.

When you have acquired the code, call **GILES Tech Service @ 800.554.4537** and inform the *Tech Service representative* of the code and they will enter it into the **KITCHENTRAC®** website.

2. If a **PAIR CODE** did not appear during *Step #1*, you might try viewing the “WIFI SYSTEM LOG” on the fryer controller screen to acquire it.
 - Press [TIME] key + **7 7 7 7** + [START] key on controller.
 - Press keypad right arrow key [6>] until “WIFI SYSTEM LOG” is displayed on the *upper screen*.
 - A **PAIR CODE** should be shown.
 - Call **GILES Tech Service @ 800.554.4537** & communicate the displayed code to the *Tech Service representative* for entering into the **KITCHENTRAC®** website.

3. After **PAIR CODE** has been entered, verify that the controller is actually connected to the server.

To confirm connection success, enter *controller diagnostics mode* by pressing [TIME] key + **7 7 7 7** + [START] key, then press keypad right arrow key [6>] until *upper display* shows *Connection Status* ... displaying either “SERVER CONNECTED” or “NOT CONNECTED”.

If communication has not been established, it is possible that there are problems with internet connectivity at your location, or the wireless router is possibly not within range of the appliance. **Please contact GILES Tech Service for assistance in resolving the issue.**

A.3 WiFi Components

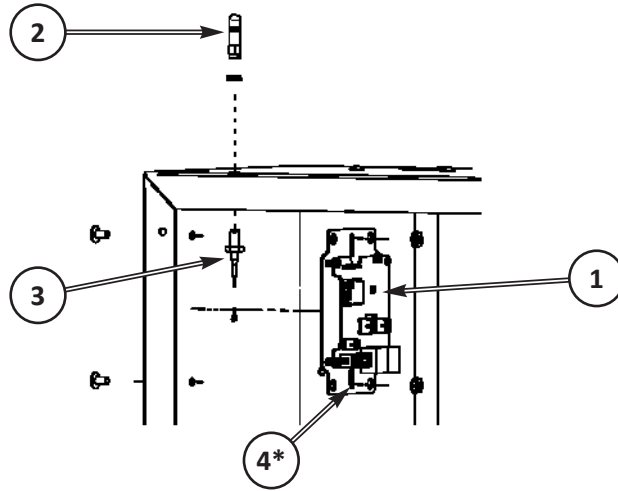

WiFi boards are located in various locations inside the appliance cabinets, depending on model. An antenna will protrude from cabinet near its location.

IMPORTANT! Take care not to damage the antenna when cleaning or servicing the equipment.

ITEM	PART NO.	QTY	DESCRIPTION
1	21606	1,2 or 3	WiFi BOARD ASSY, EXT ANTENNA
2	21613	1,2 or 3	ANTENNA, WiFi, 2.4GHz, RP-SMA, 1.8dB
3	21614	1,2 or 3	CABLE, ANTENNA, RF, U.FL TO RP-SMA, 15-IN
4	21454*	1,2 or 3	CABLE, CONNECTOR, RJ45, PLUG-TO-PLUG. 6-FT

* Not shown - connects board to controller in the Control Panel on front of unit.

NOTE: These components are included on each unit of a multi-well appliance.



PROVEN & TRUSTED SINCE 1952

GILES Food Service Equipment

ISO 9001-2015 Certified

2750 Gunter Park Drive West • Montgomery, AL 36109 USA
Phone 334.272.1457 • Fax 334.239.4117 • Phone Toll Free 800.554.4537
Website: www.gfse.com • Email: services@gfse.com

66320
REV-C
ECO3395
02/14/2025
PRINTED IN USA